

# Aquaforce 2000

Unité mobile de traitement de l'eau  
en situation d'urgence humanitaire

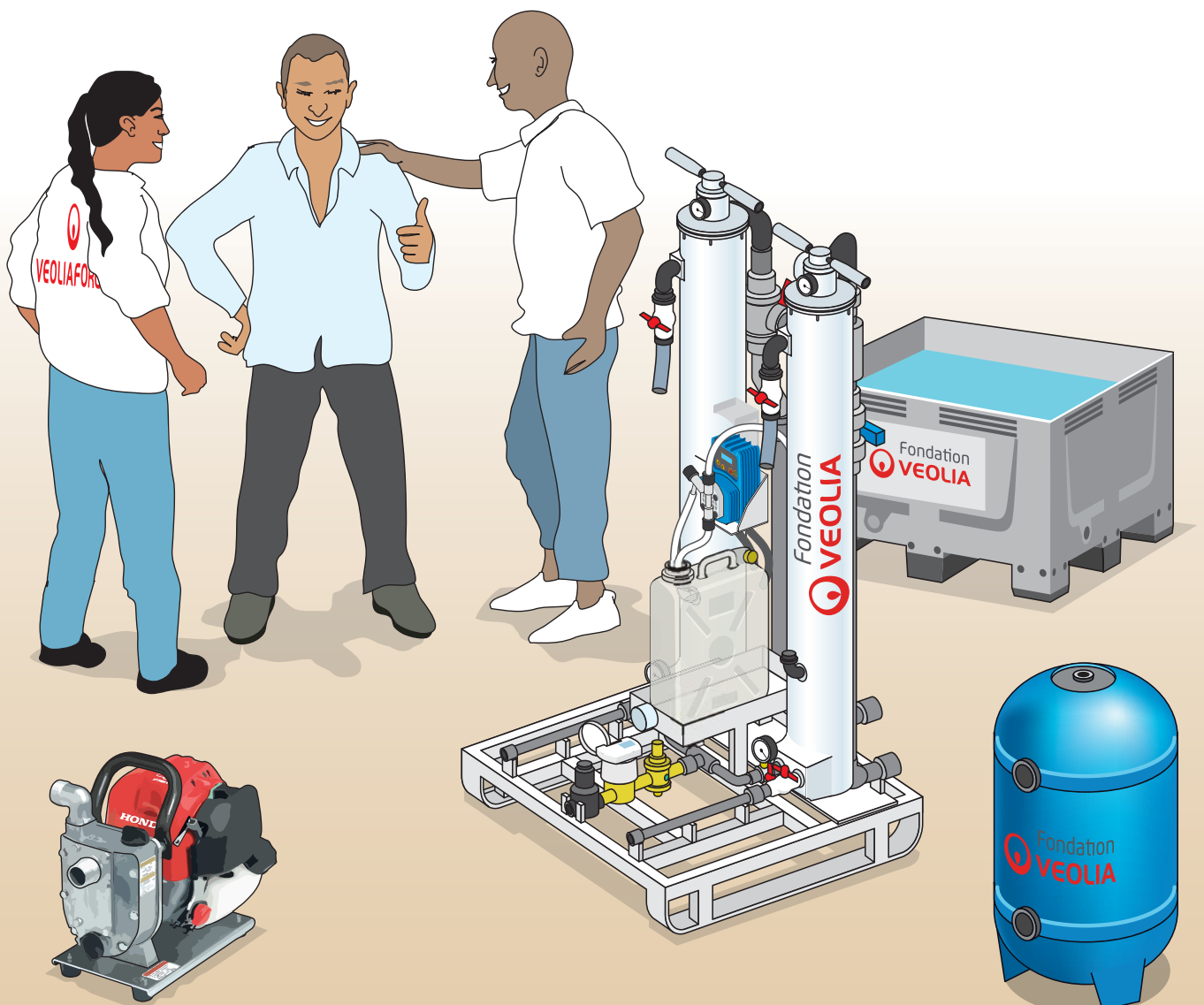

# AQUAFORCE 2000

Unité mobile de traitement d'eau utilisée sur des terrains difficiles d'accès par les volontaires de la FV en situation d'urgence. L'Aquaforce 2000 permet de fournir 20 litres d'eau potable par personne et par jour\* à une population allant jusqu'à 2 000 personnes ou d'appuyer un centre de santé.

\*recommandation de l'OMS (Organisation Mondiale de la Santé).

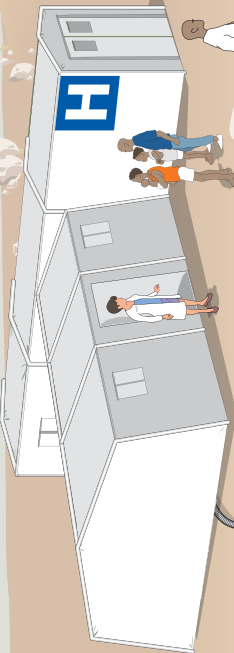

## 6 DISTRIBUTION

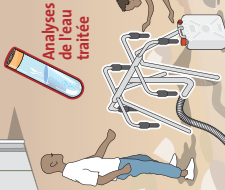

## 3 FILTRATION CHARBON



## 2 ULTRAFILTRATION



**LA FILTRATION**  
Exemple d'utilisation (2 m<sup>3</sup>/h)  
L'ultrafiltration par membrane permet d'éliminer la totalité des matières en suspension, ainsi que la majorité des micro-organismes pathogènes présents dans l'eau.  
→ 20 litres par jour par personne  
→ Capacité jusqu'à 2 000 personnes selon la qualité d'eau puisée



Pompe doseuse  
Injection de la solution de chlore dans le réseau d'eau traitée

## 4 DÉSINFECTION

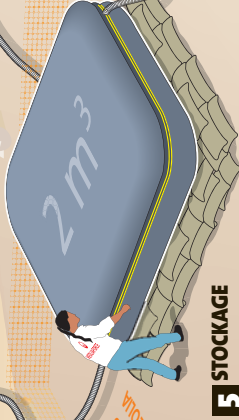

## 5 STOCKAGE

Régulation débit

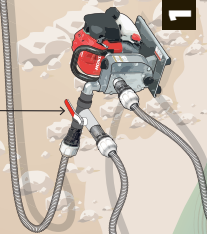

## 1 POMPAGE

Analyses de l'eau brute

Analyses de la qualité

Préfiltre

EAU BRUTE

Réservoir pour la solution de chlore

Réducteur de pression

Compteur avec tête émettrice

EAU TRAITÉE

## LA LOGISTIQUE

Grâce à l'optimisation de son poids, son ergonomie, sa robustesse, son conditionnement et sa facilité d'utilisation, l'Aquaforce 2000 est facilement transportable (avion ou pick-up).

- 270 kg de matériel
- 2,5 m<sup>3</sup> en volume
- 1h de montage





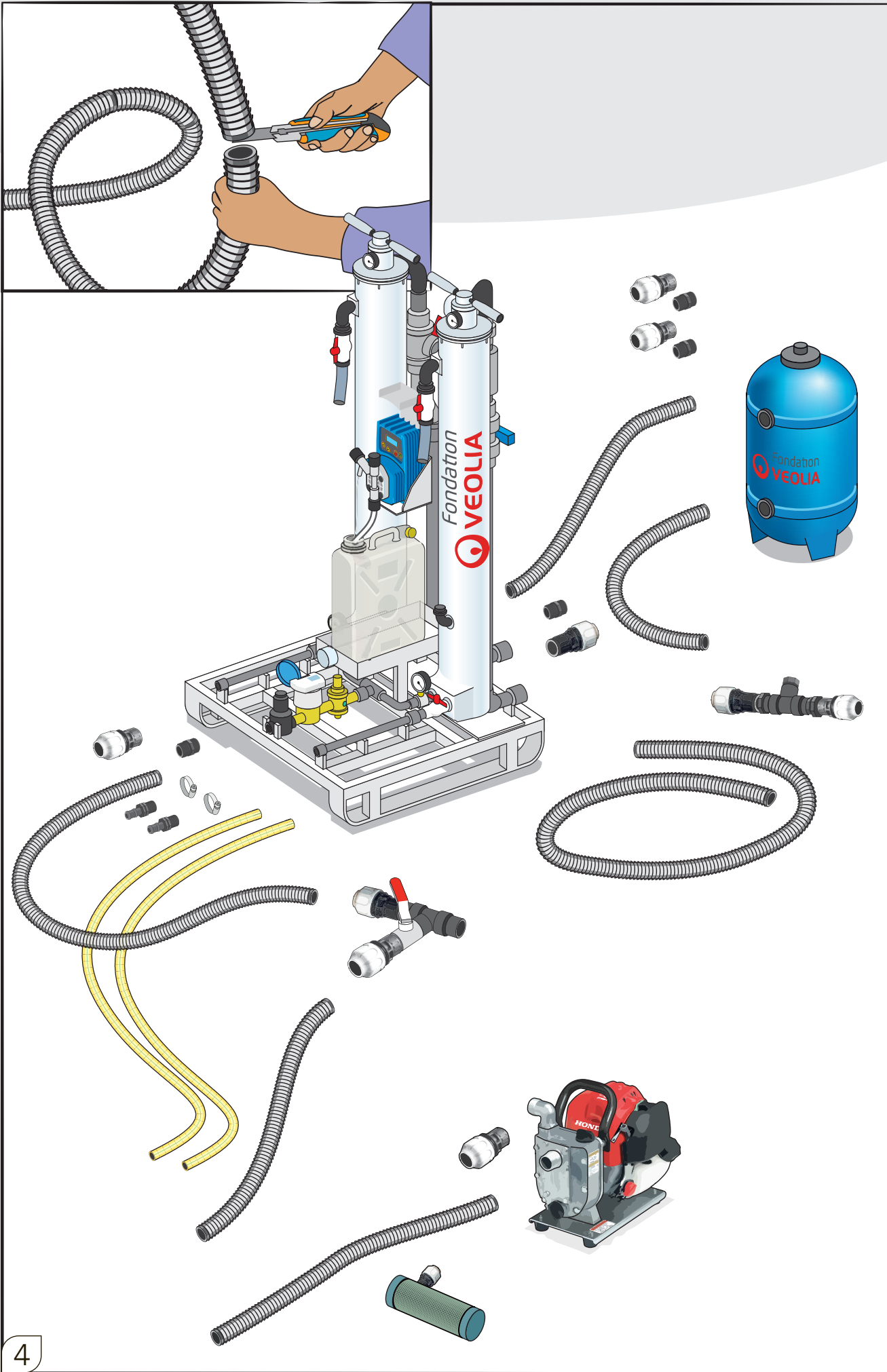

# 1 INSTALLATION DE LA MOTOPOMPE

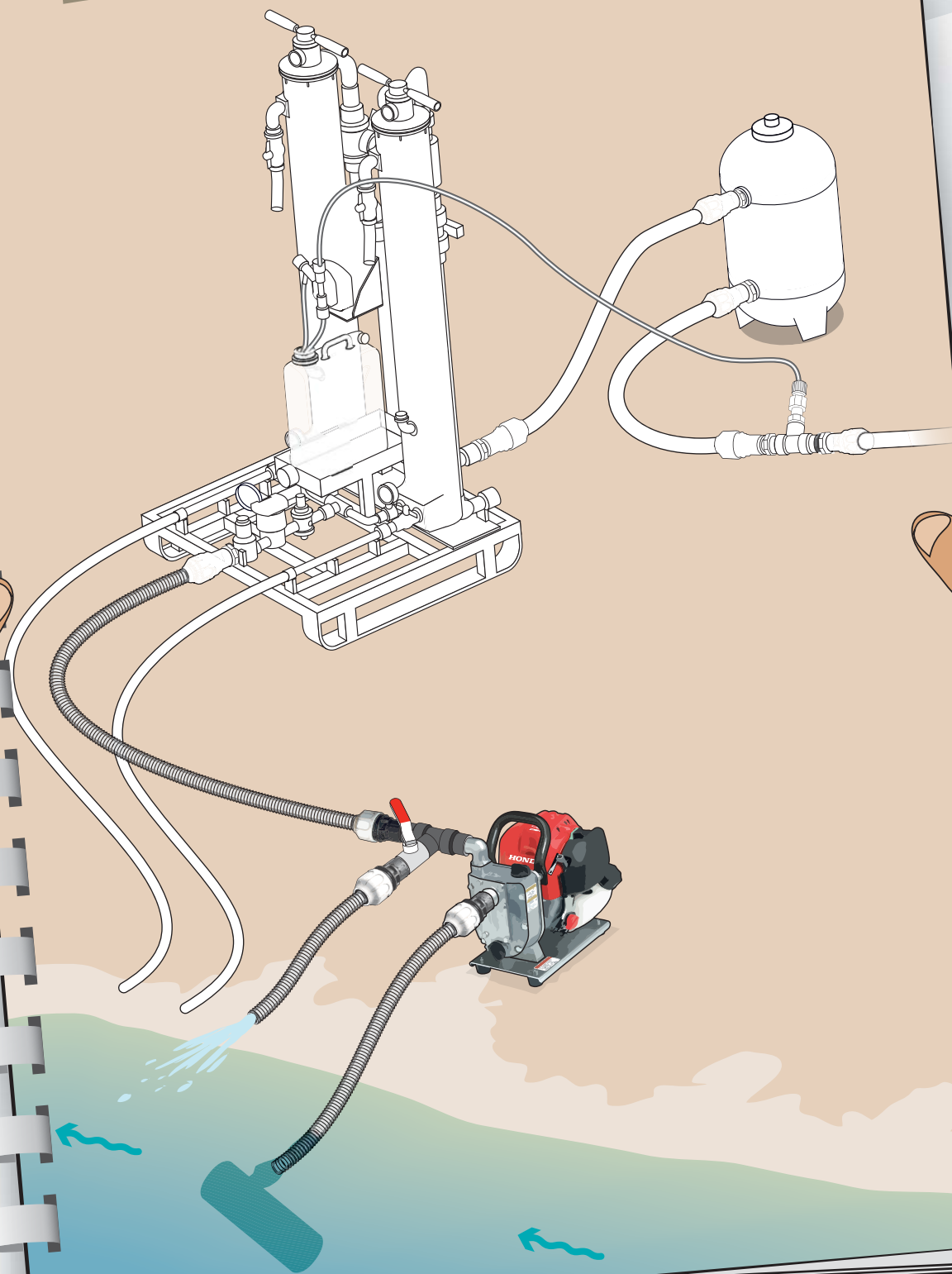

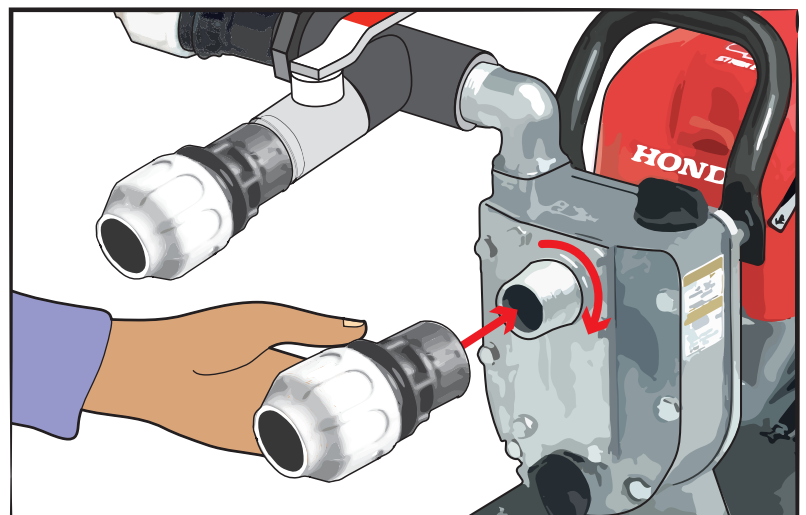
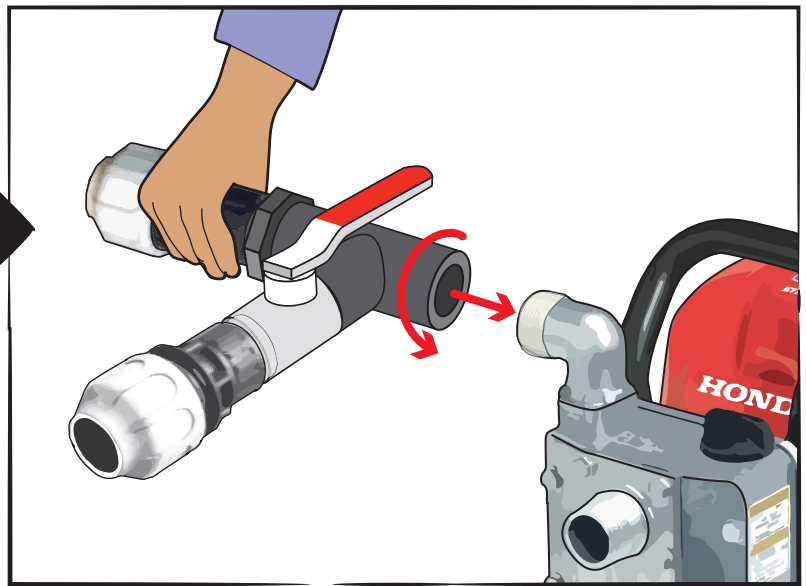
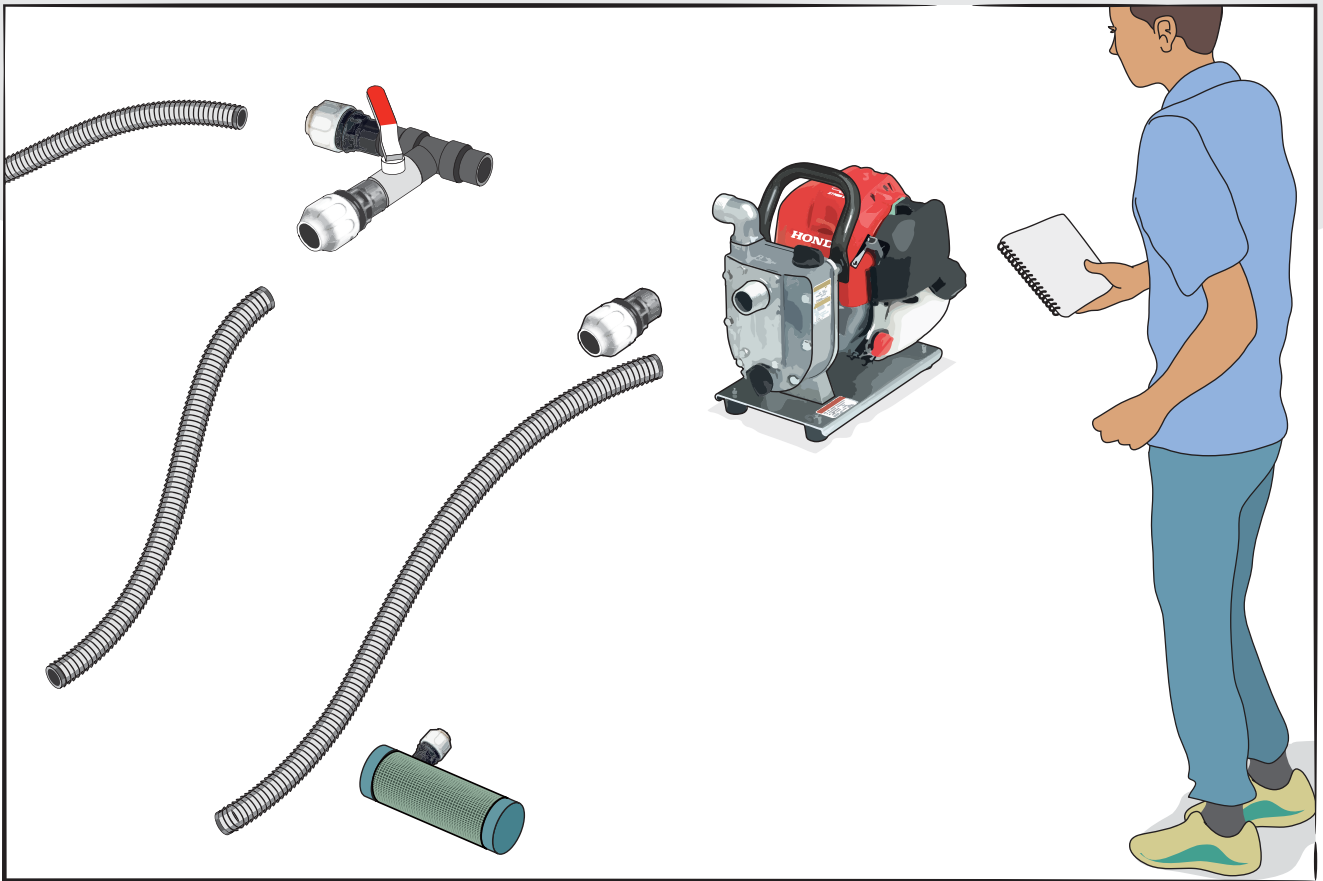

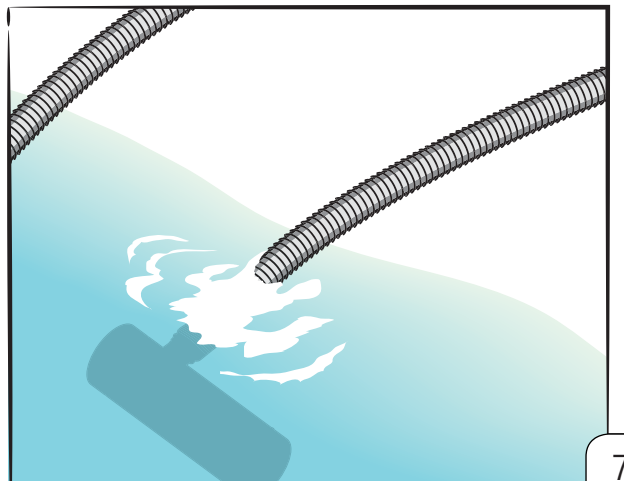
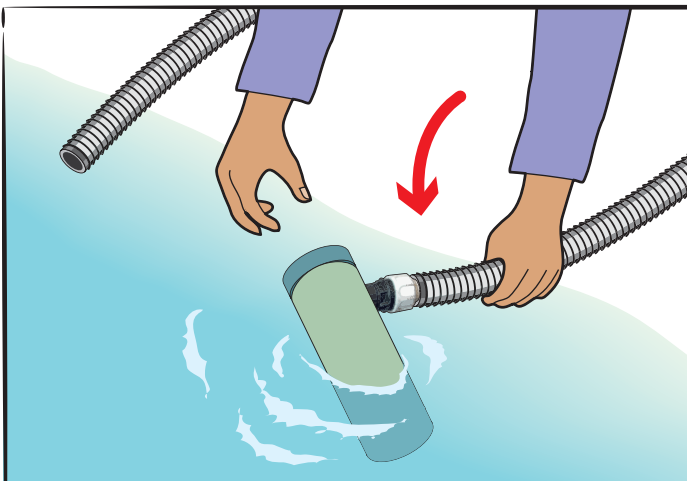
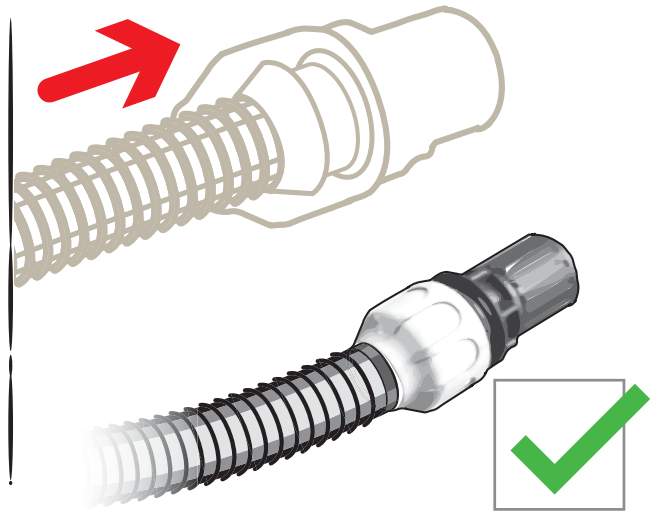
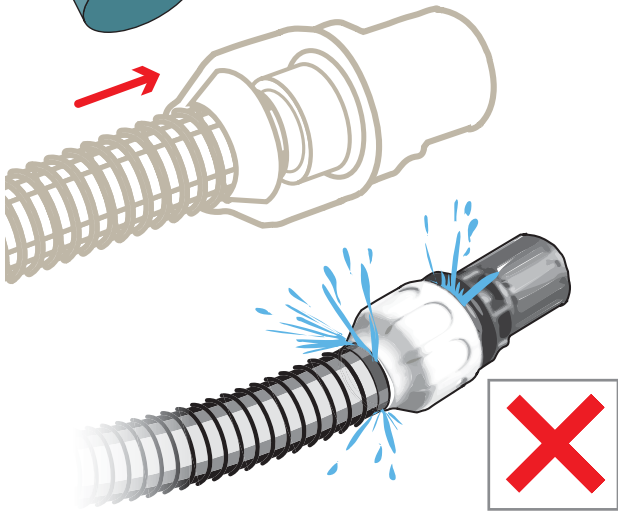
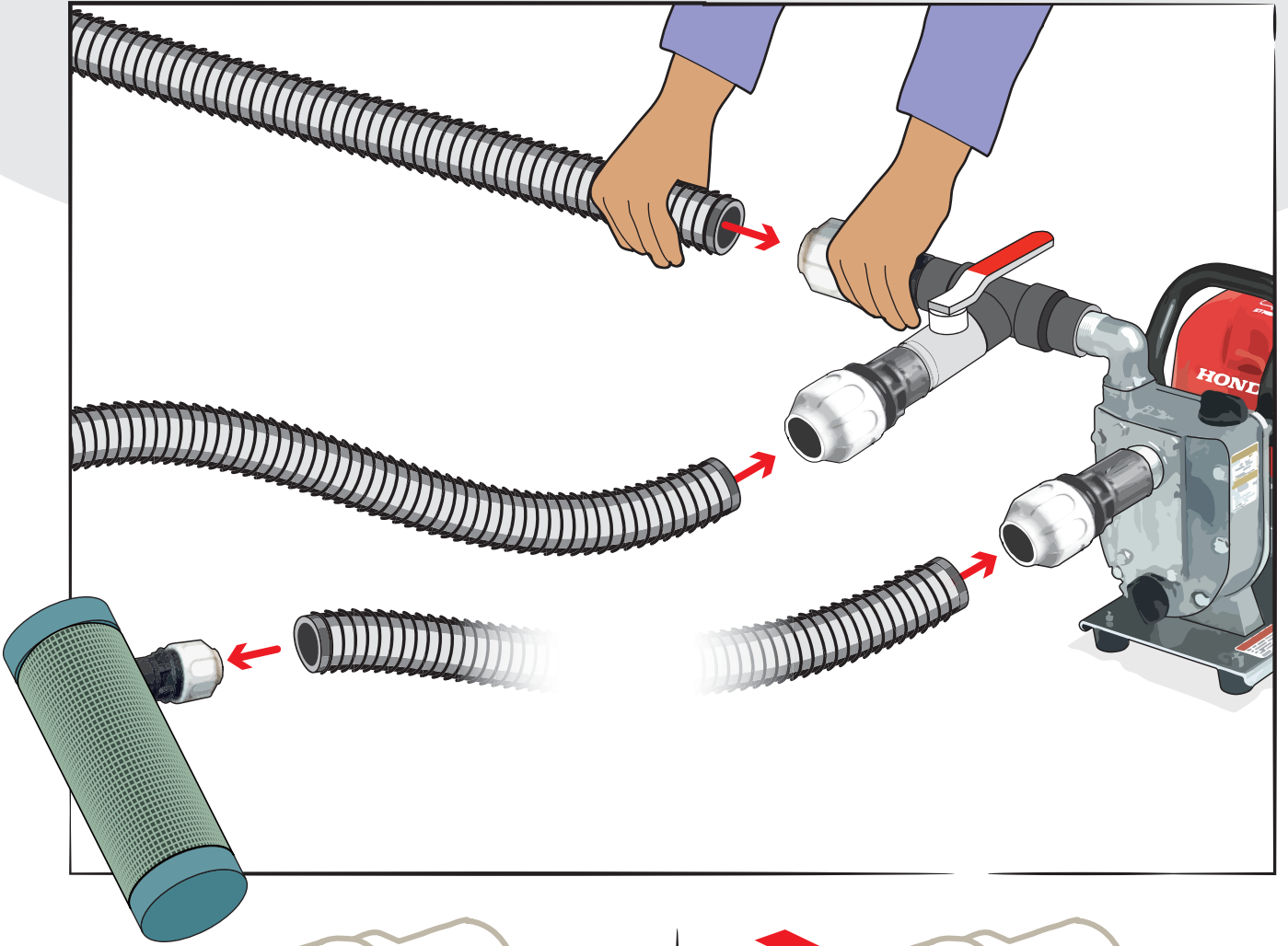

## 2 CONNEXION AU MODULE DE FILTRATION

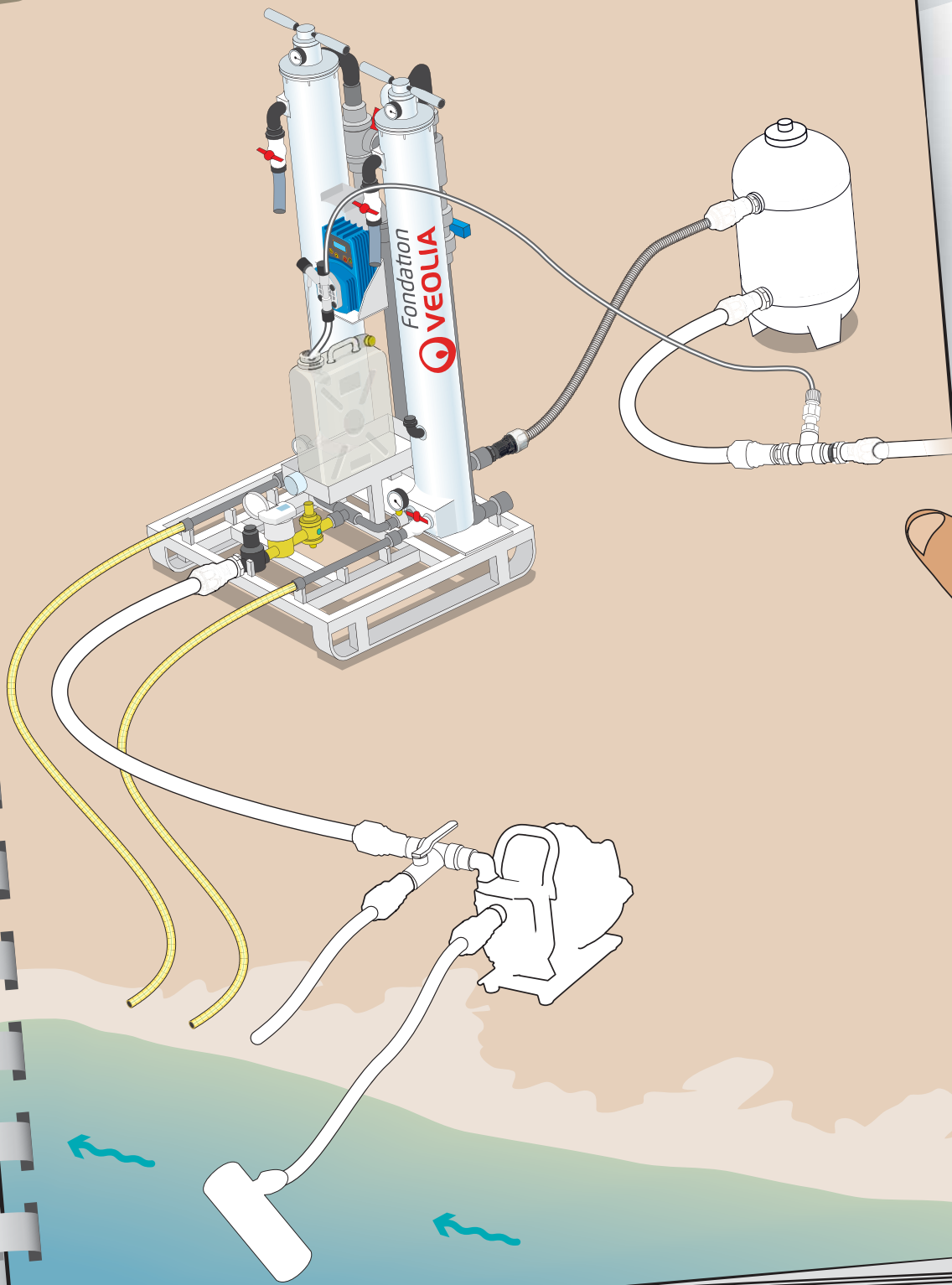



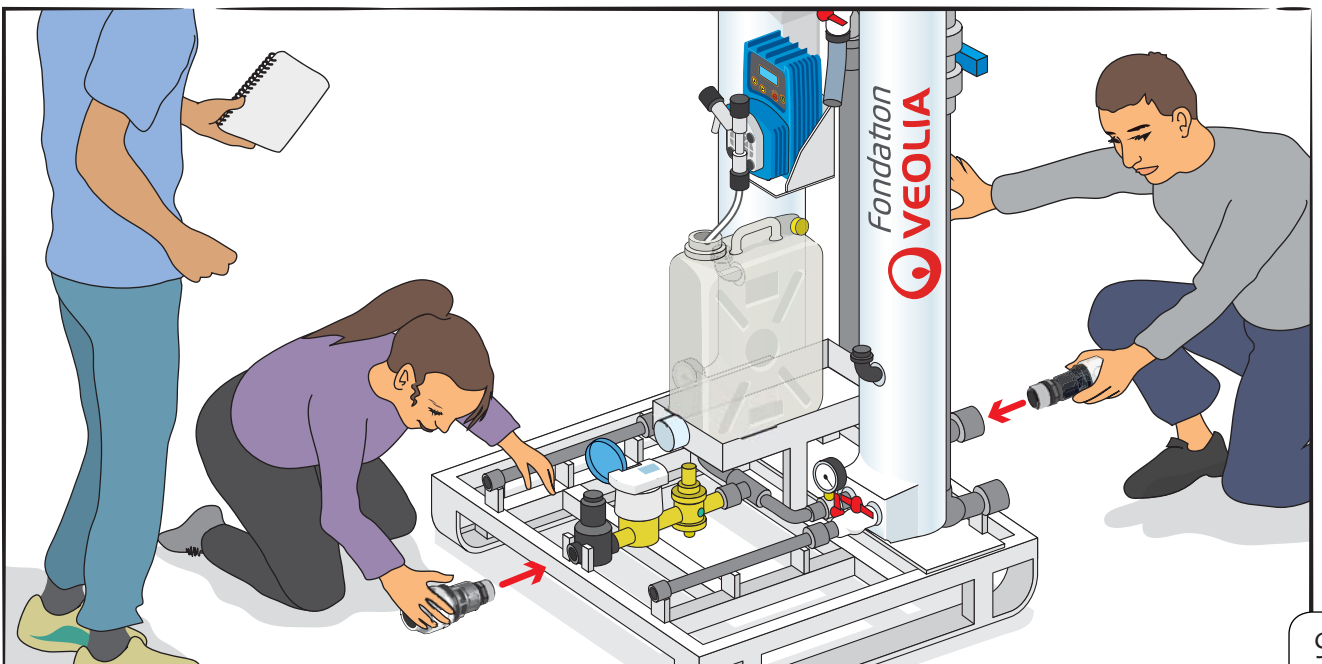
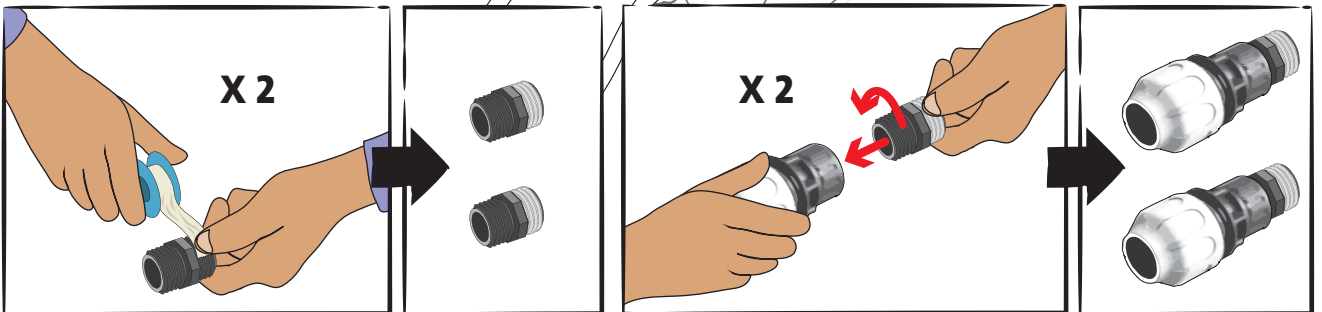
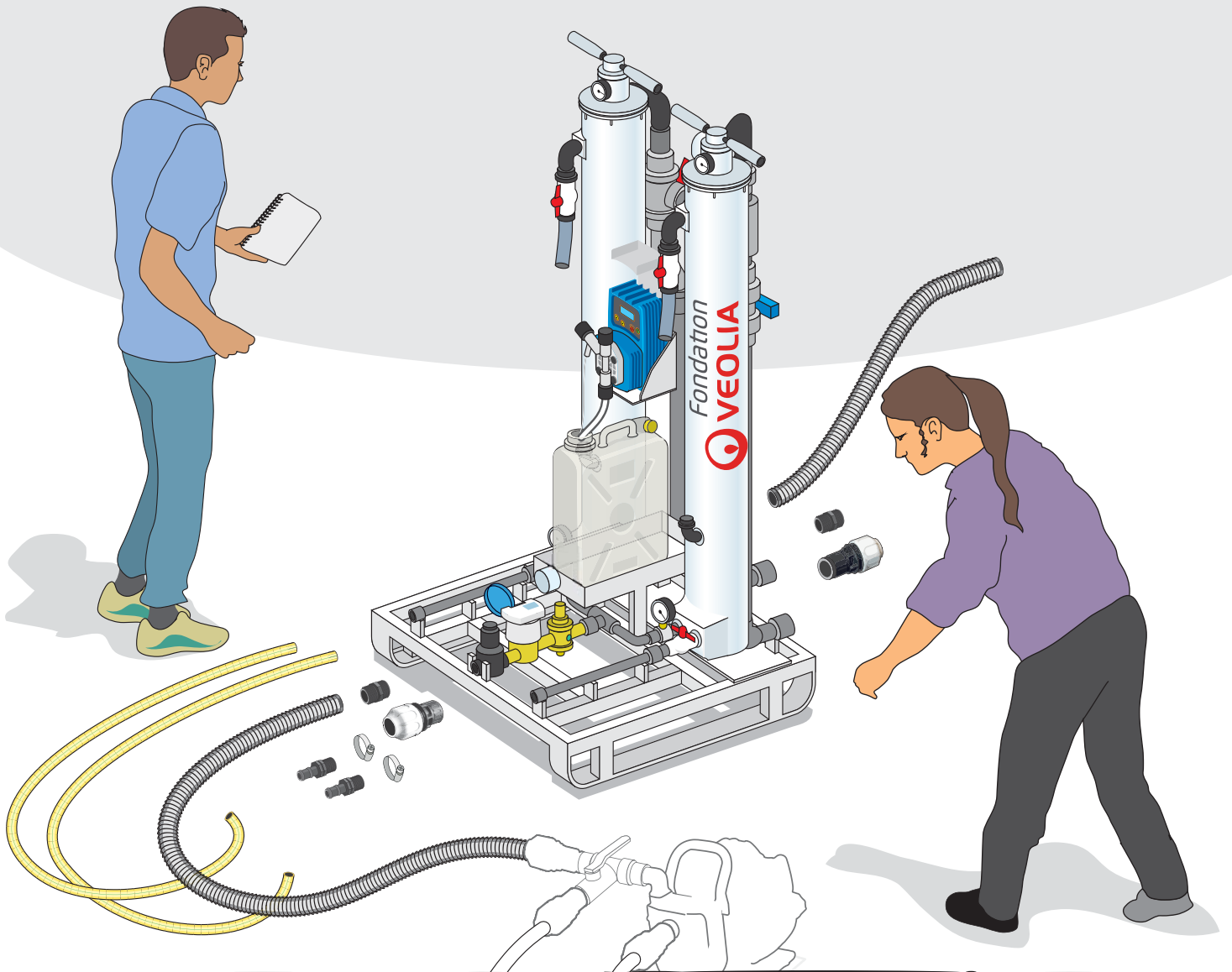

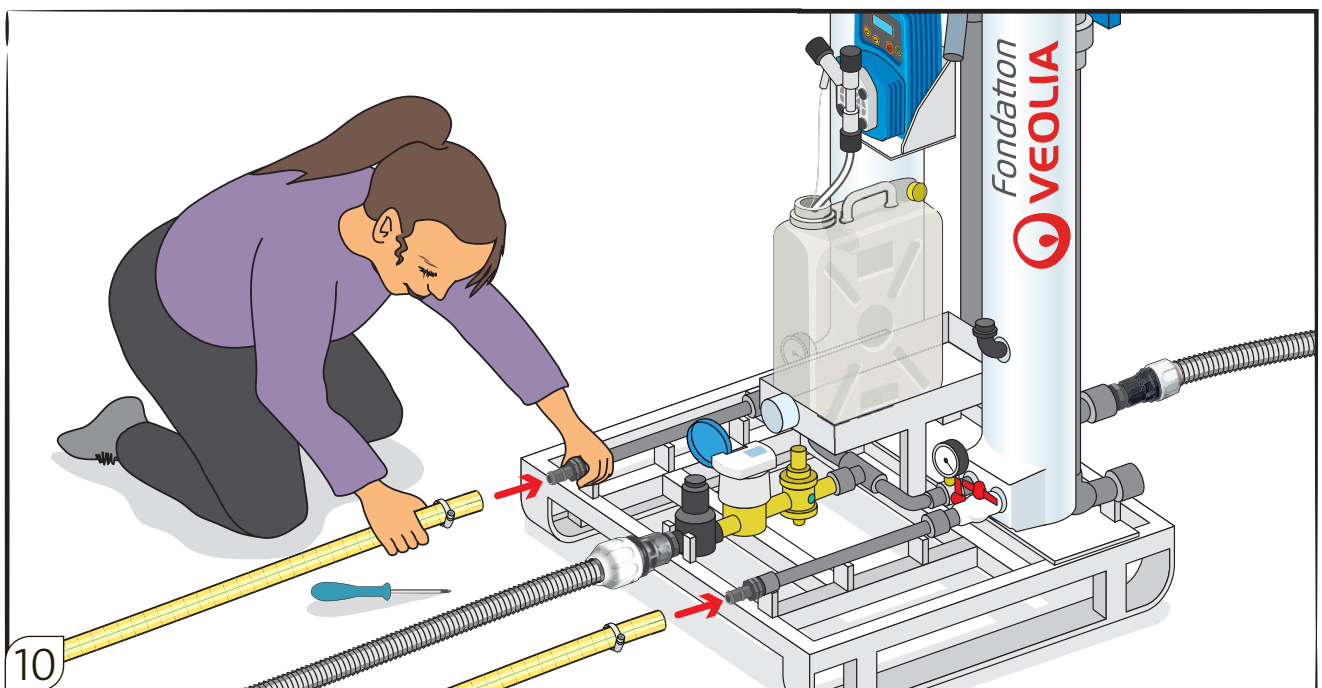
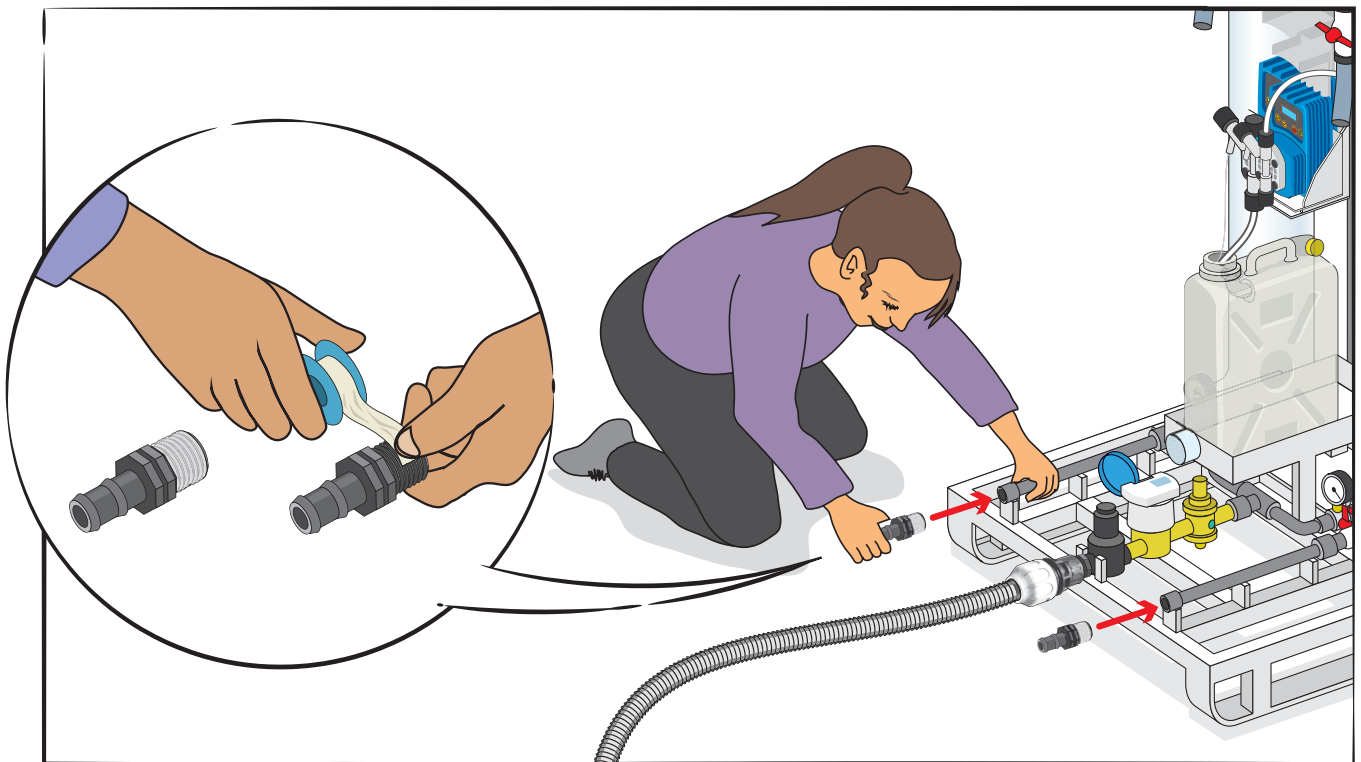
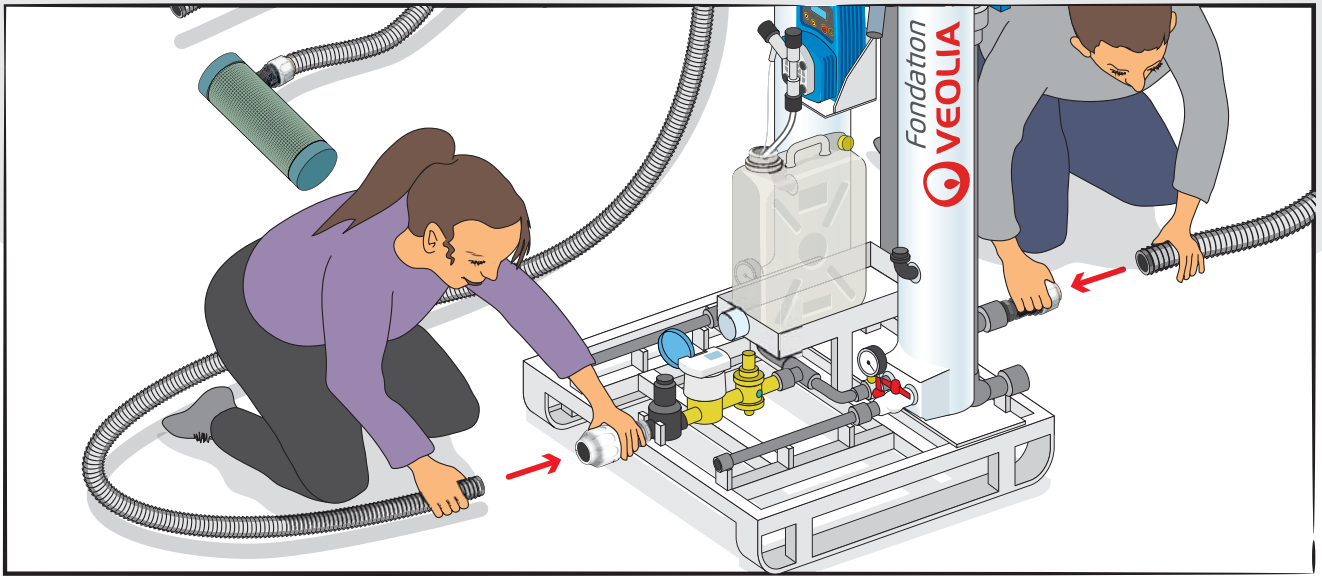

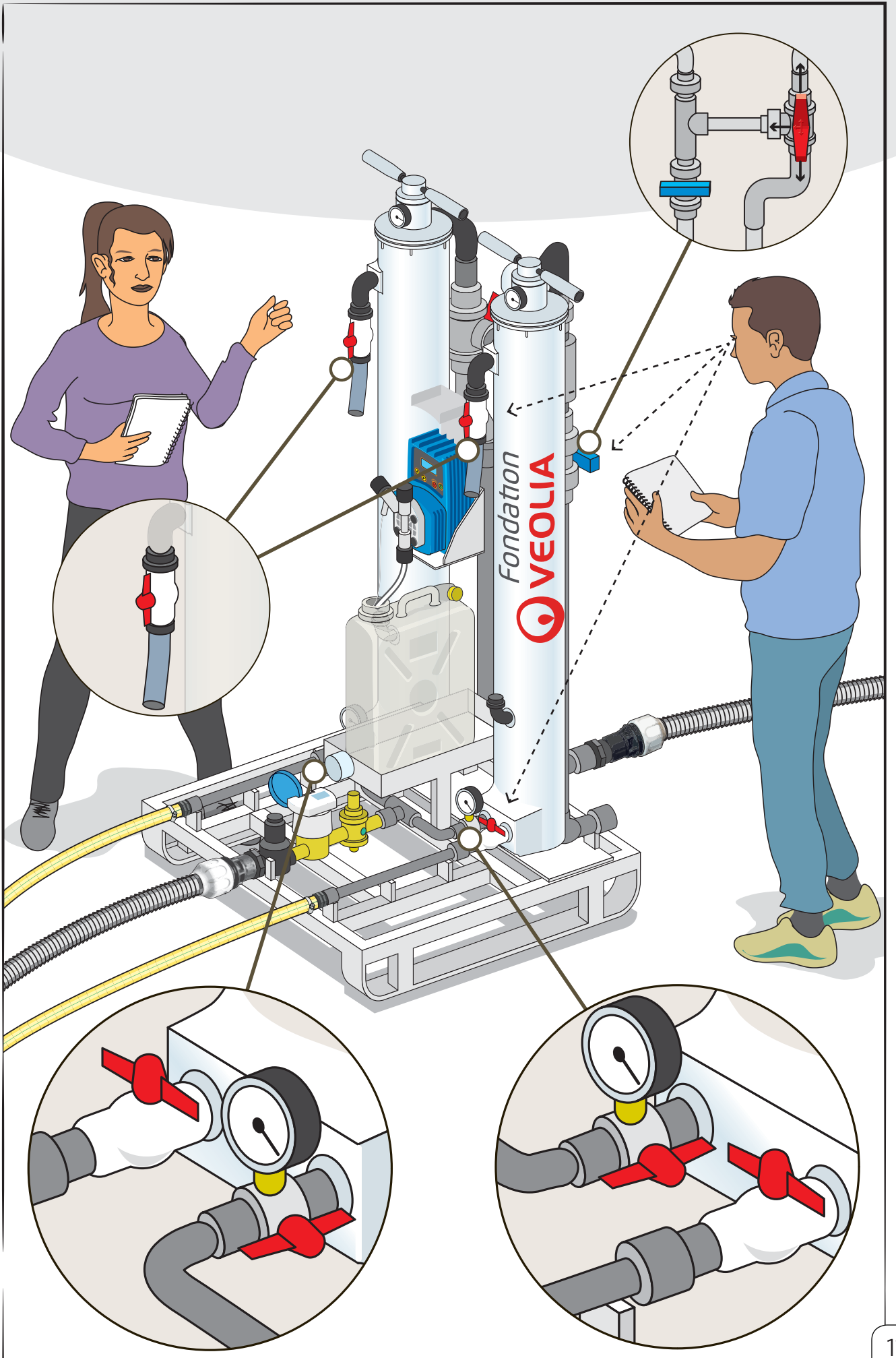

### 3 PREMIER DÉMARRAGE

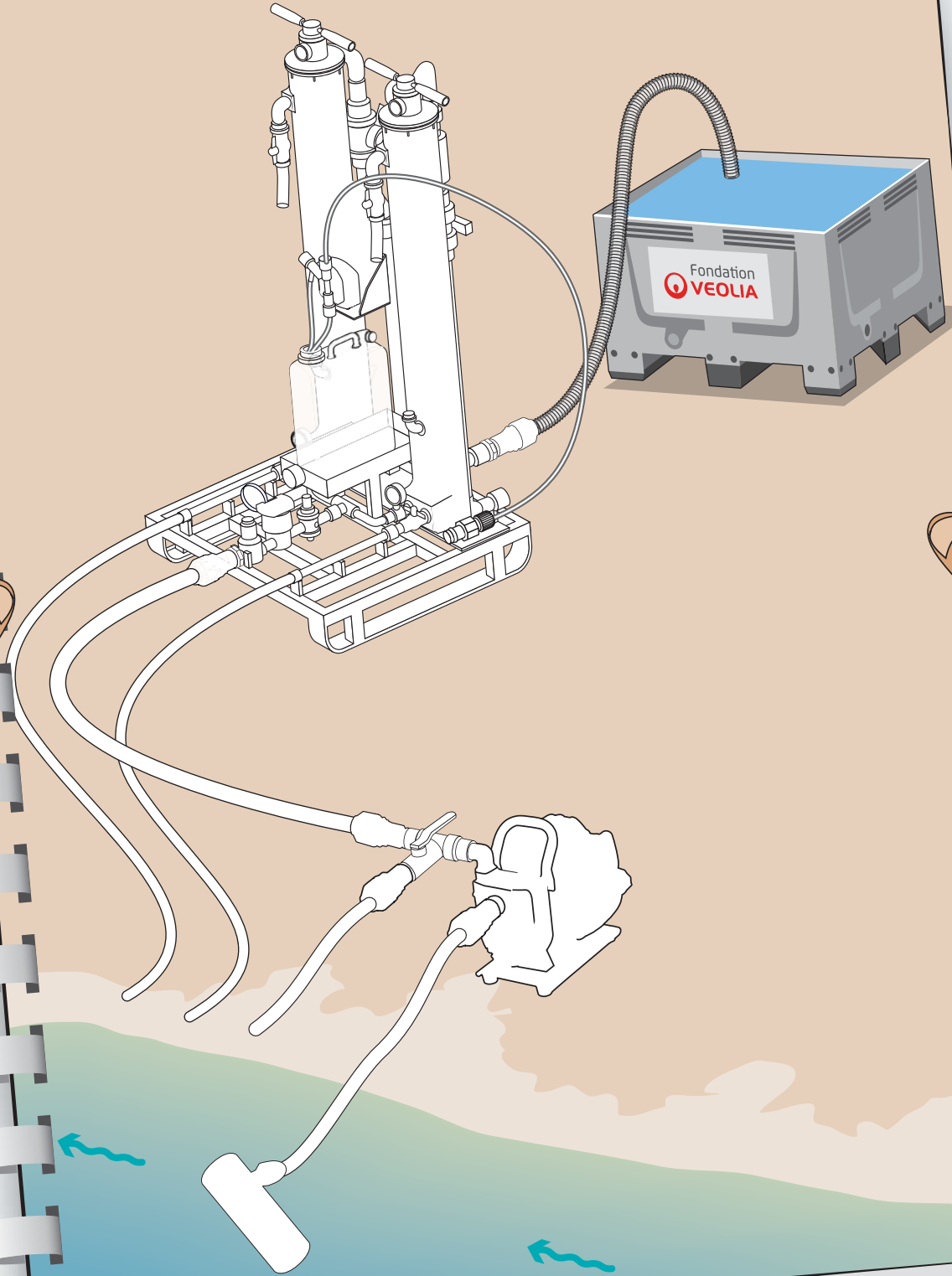

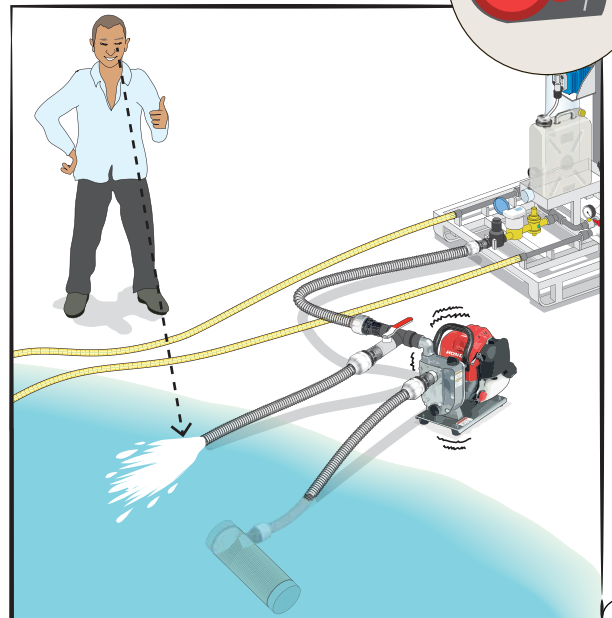
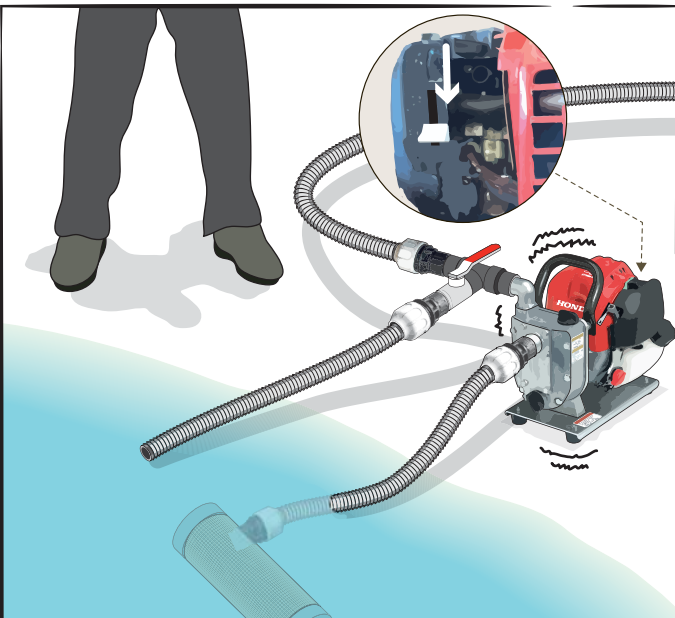
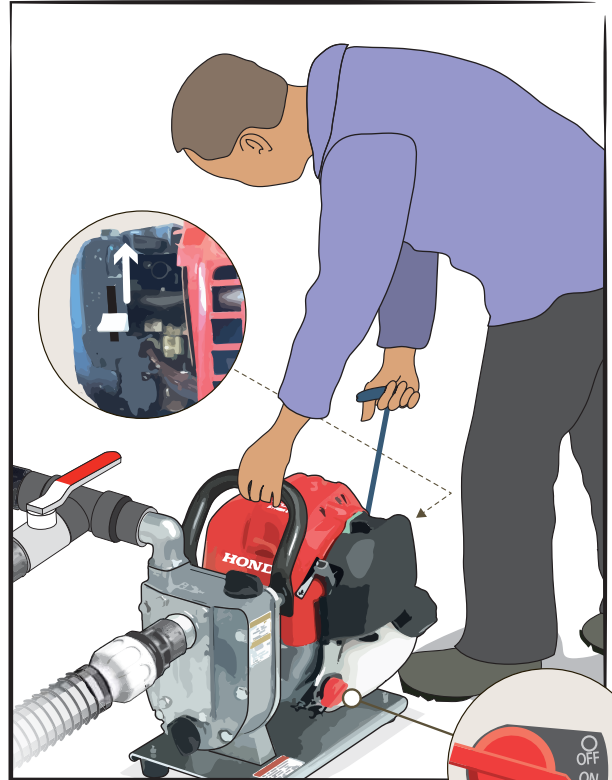
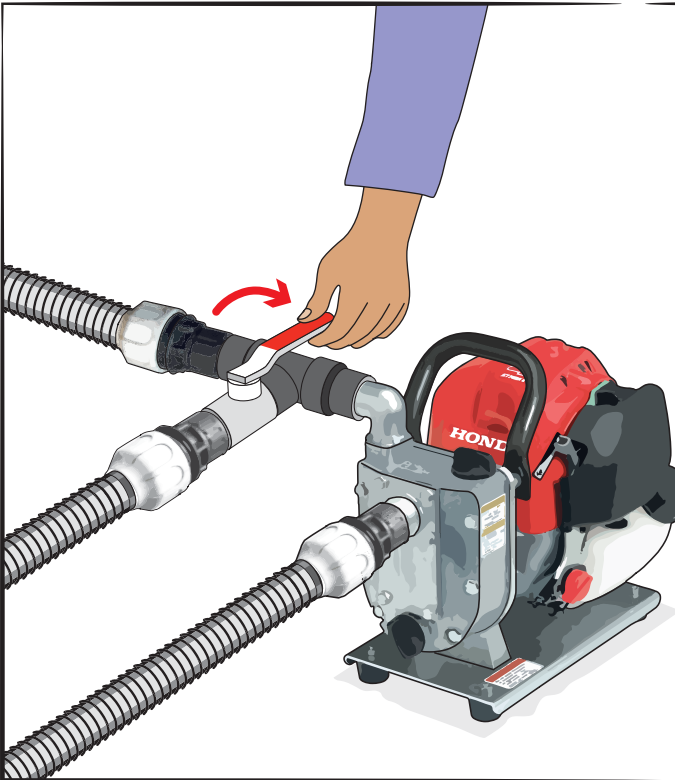
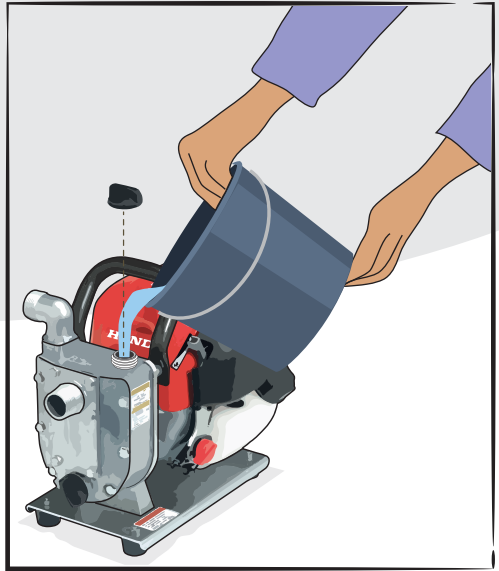
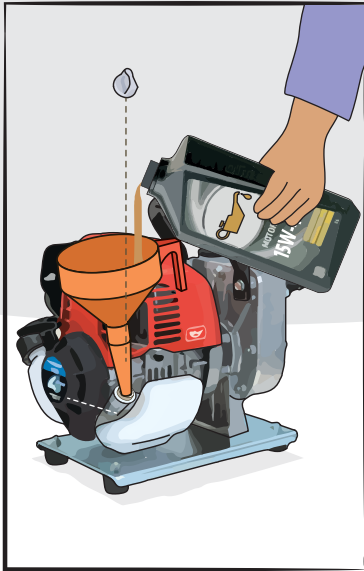
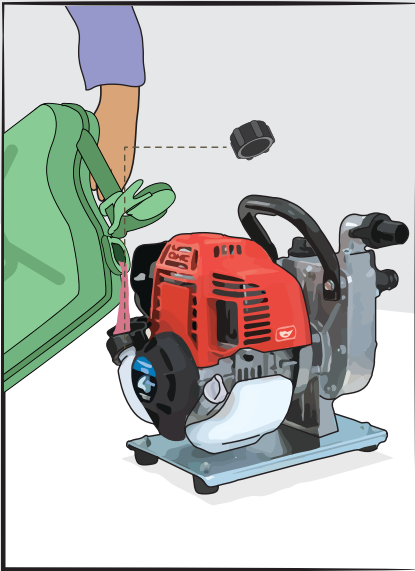

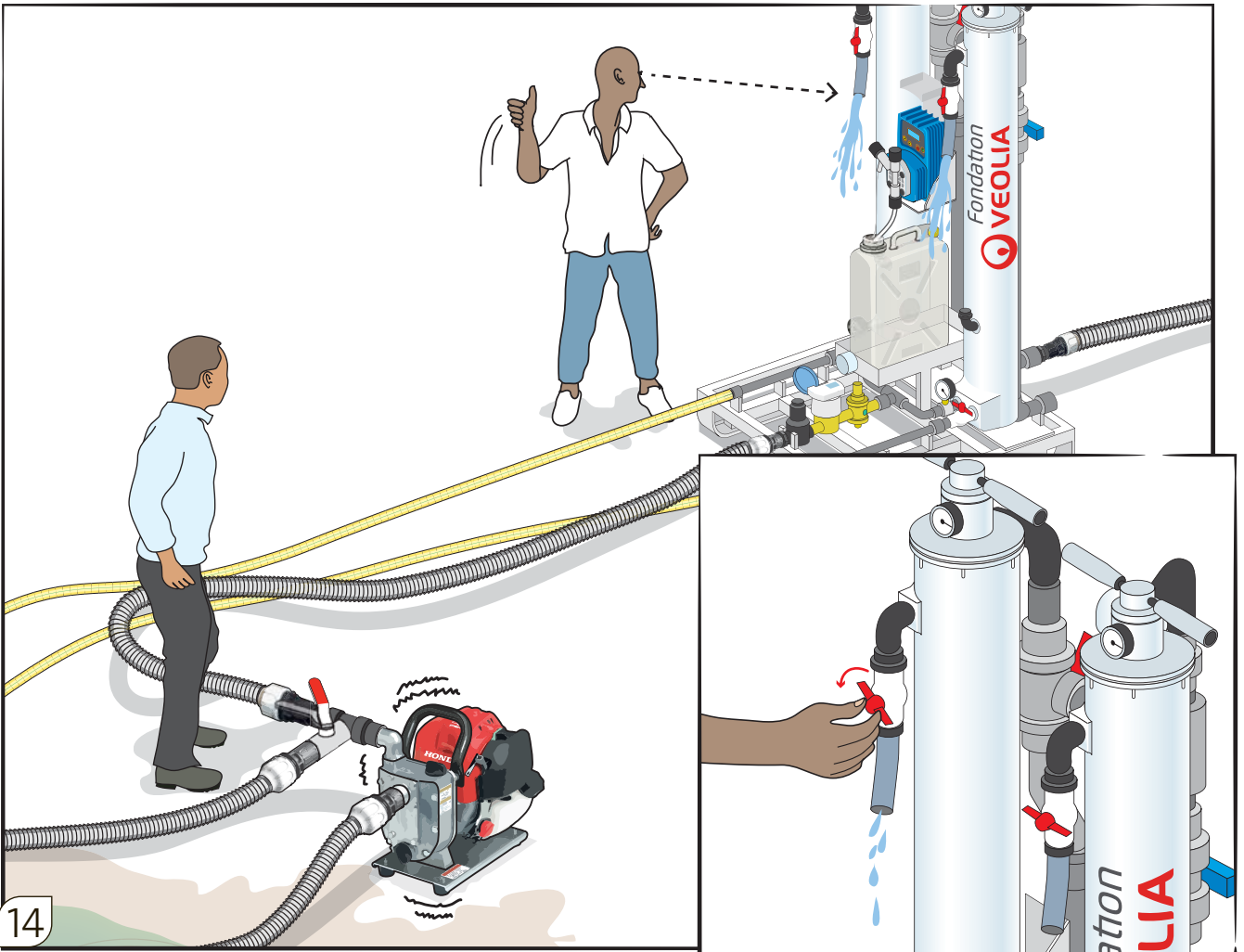
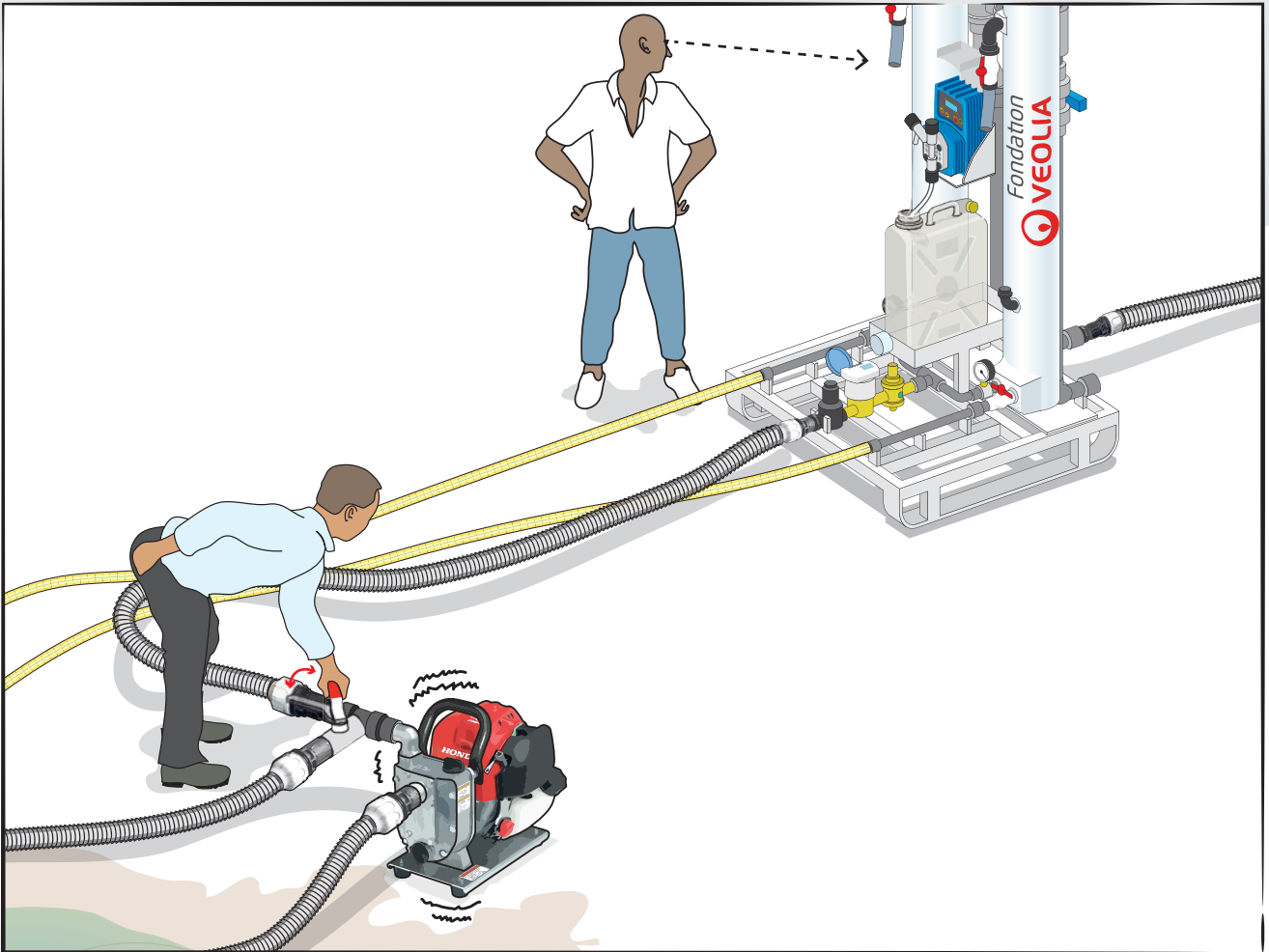

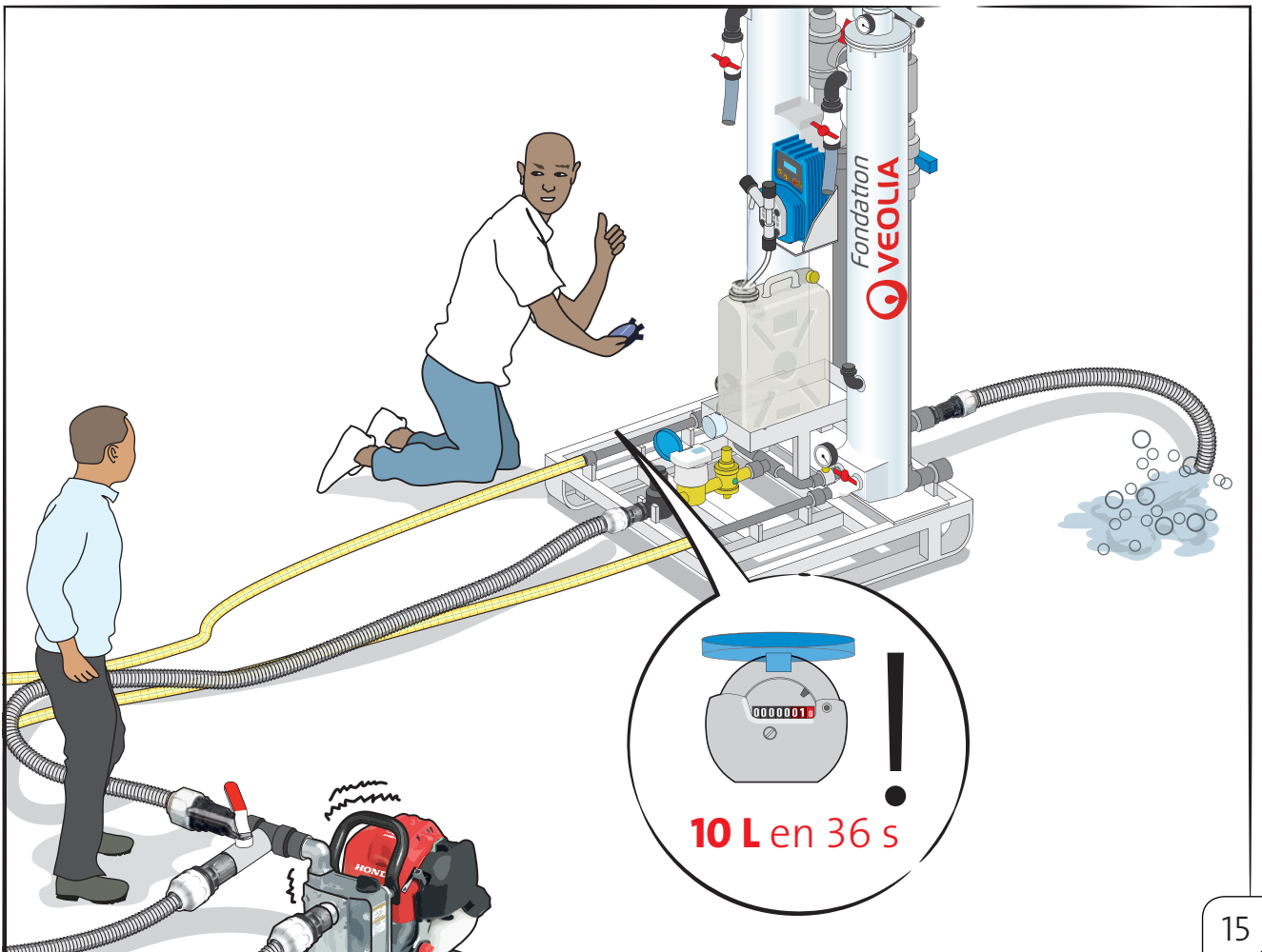
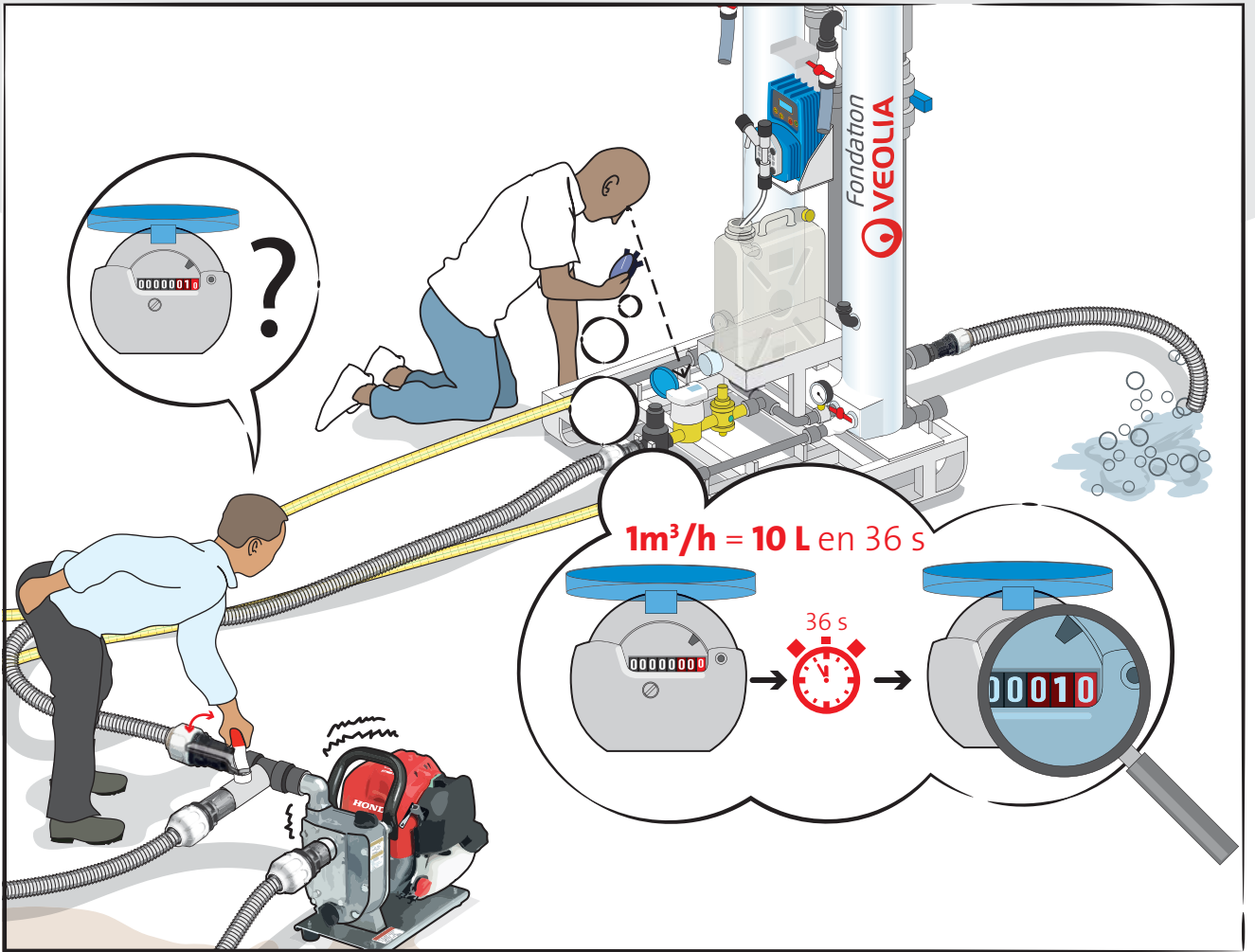

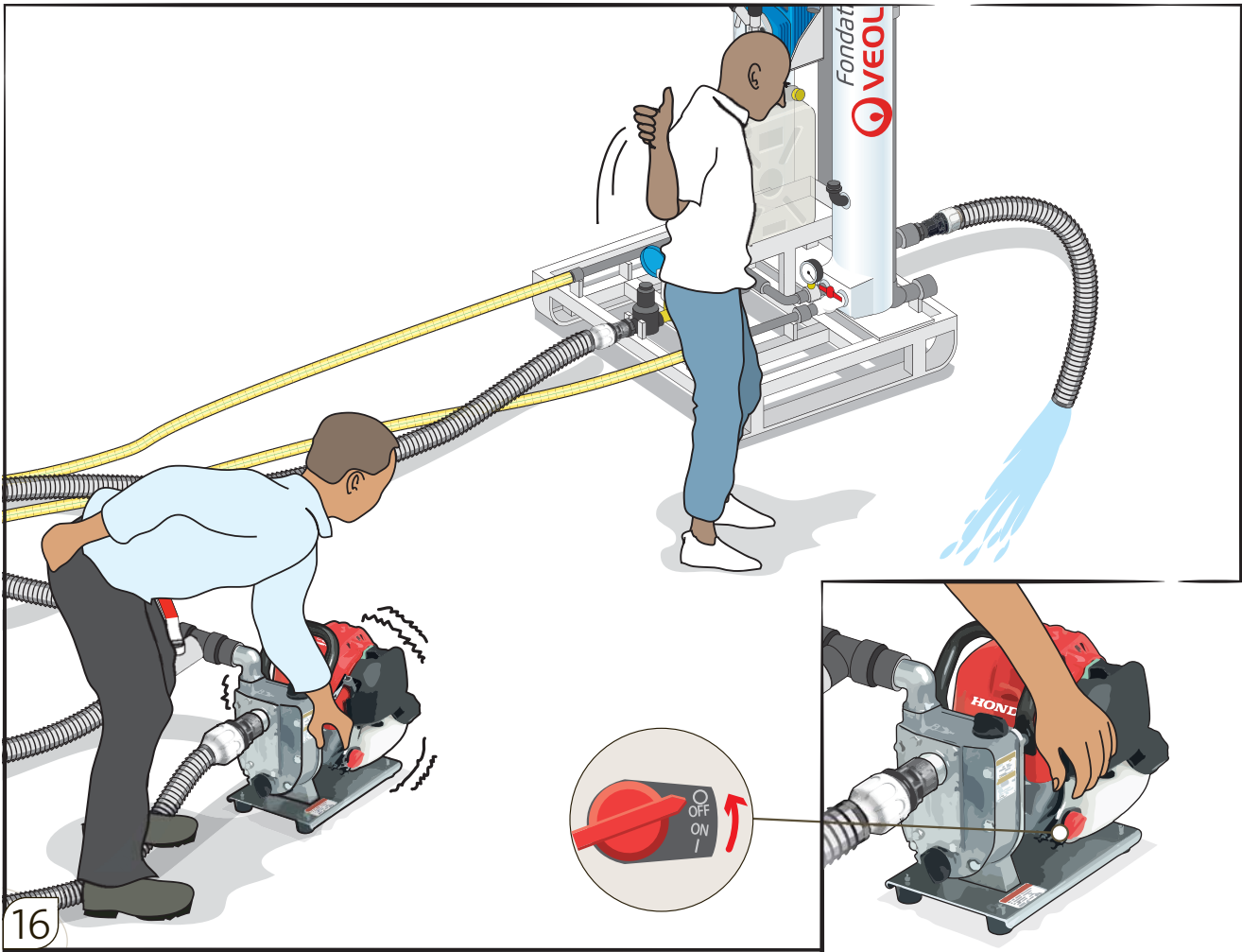
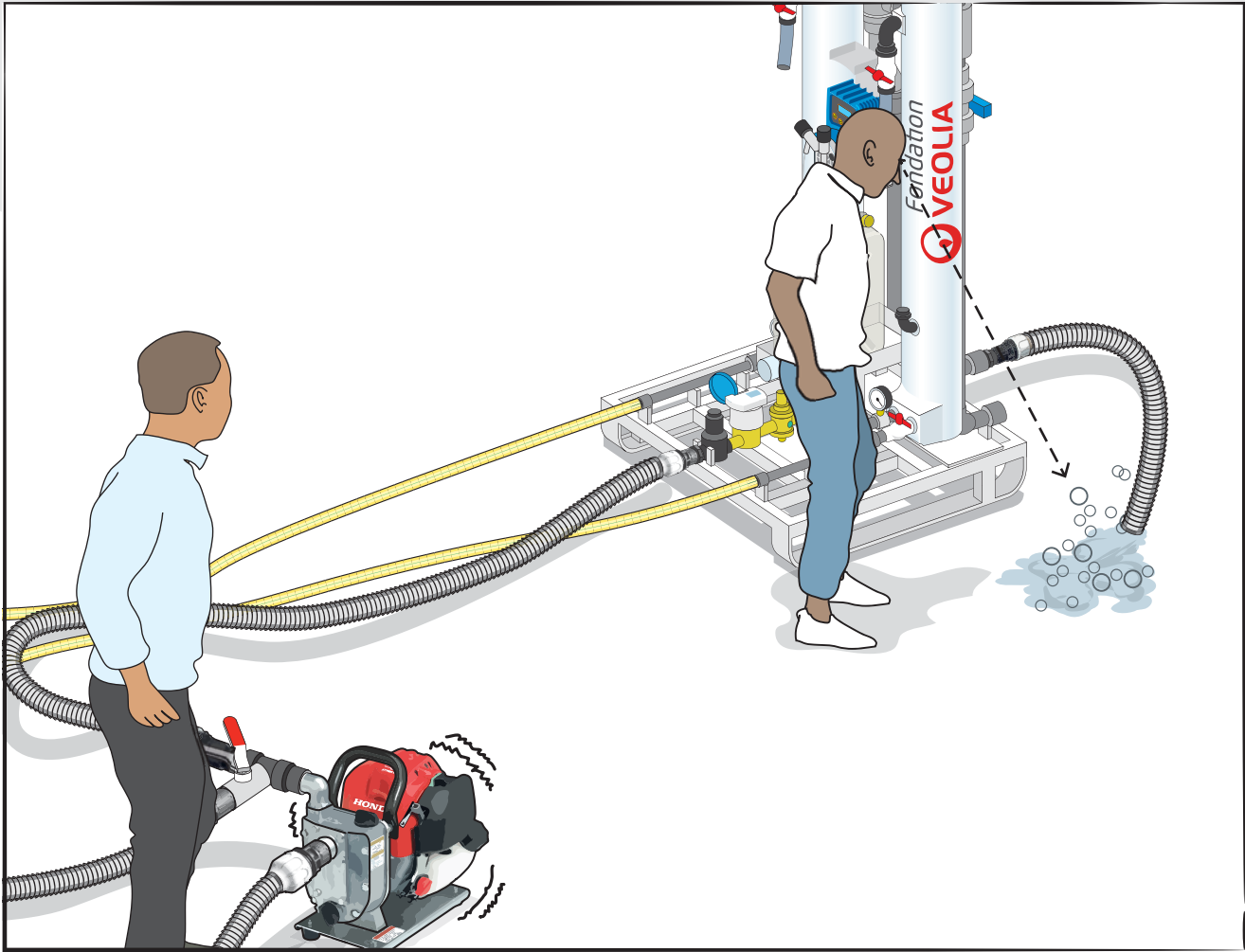



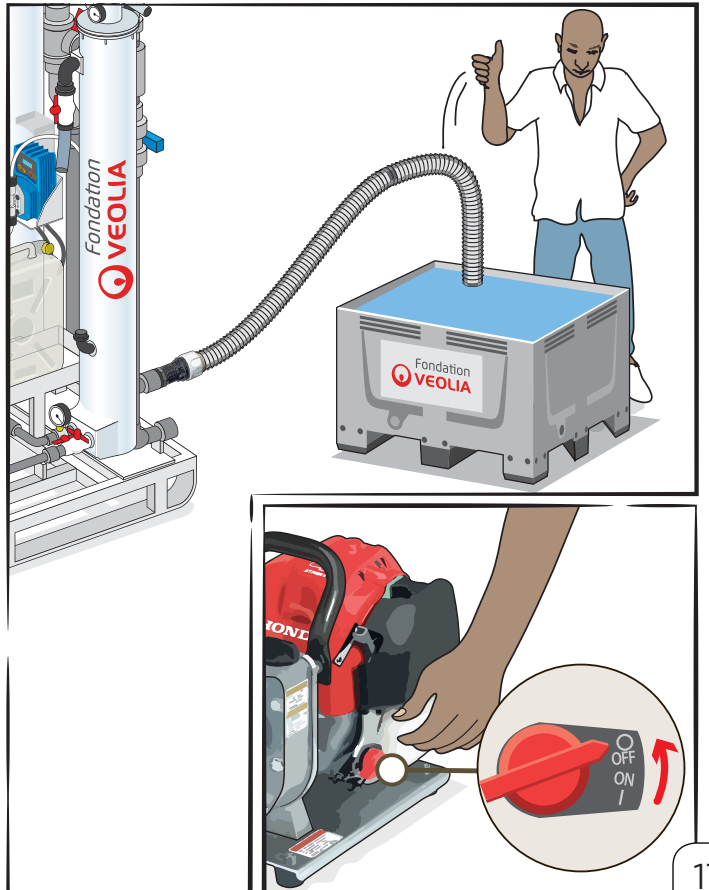
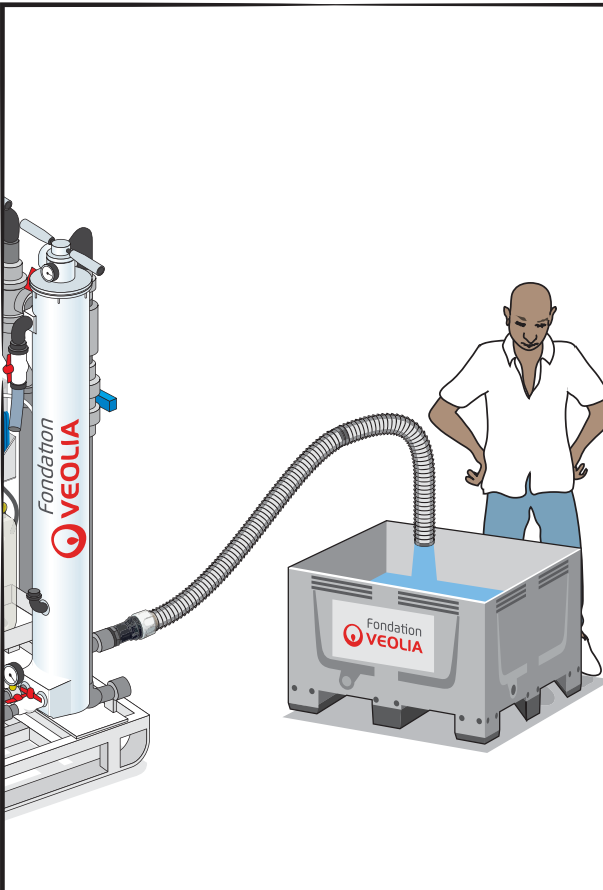
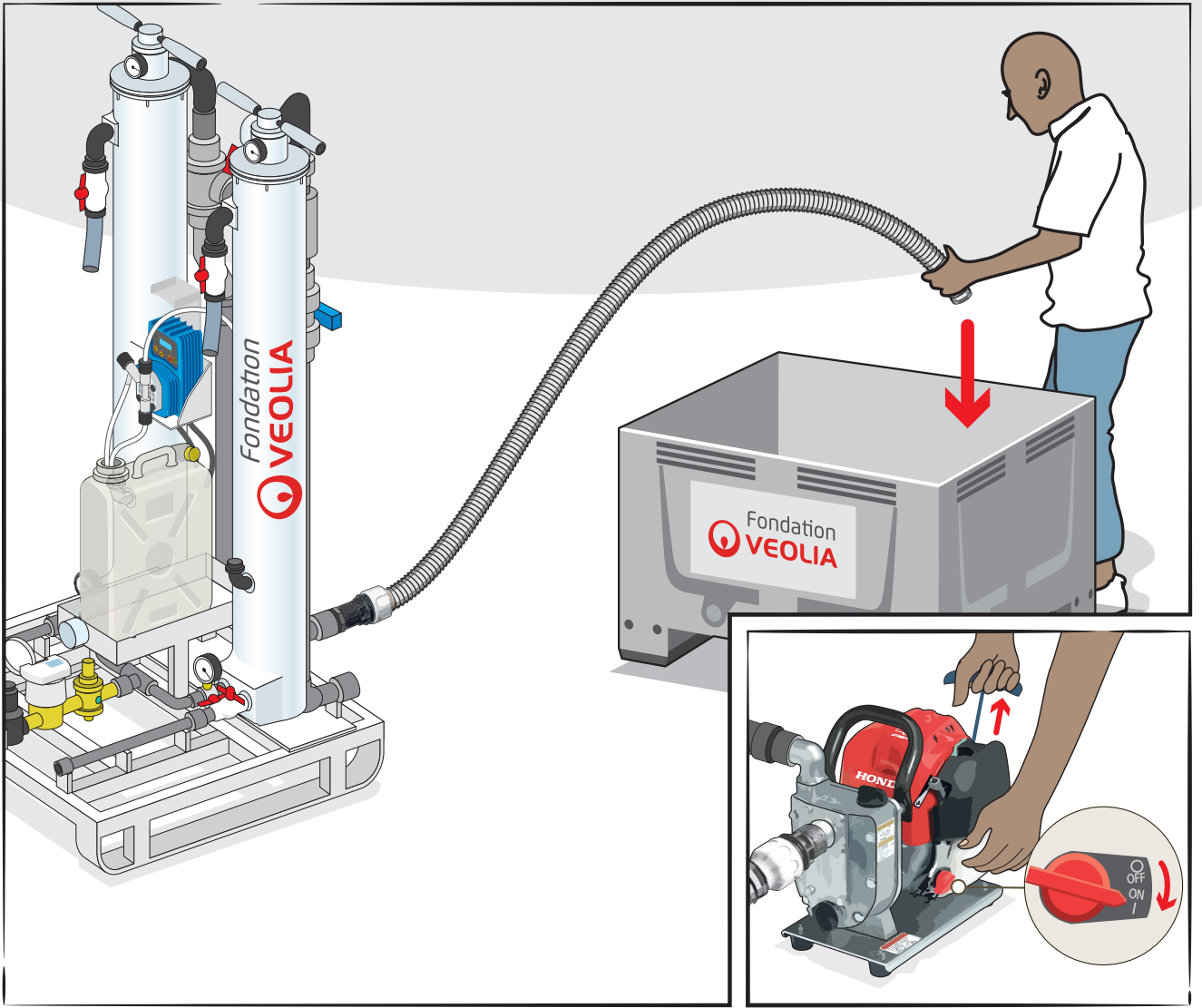

## 4 VÉRIFICATION DE L'INTÉGRITÉ DES MEMBRANES



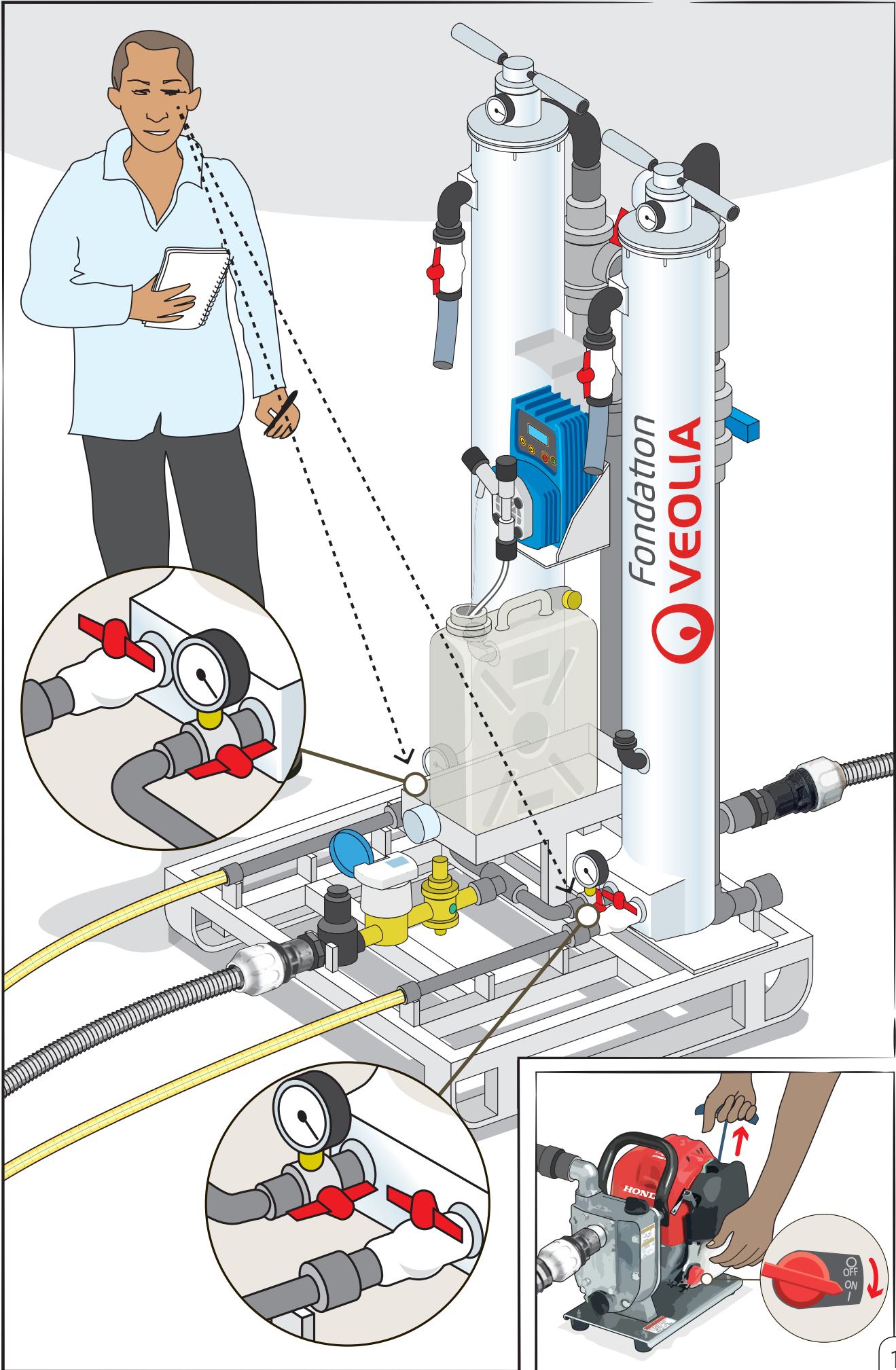

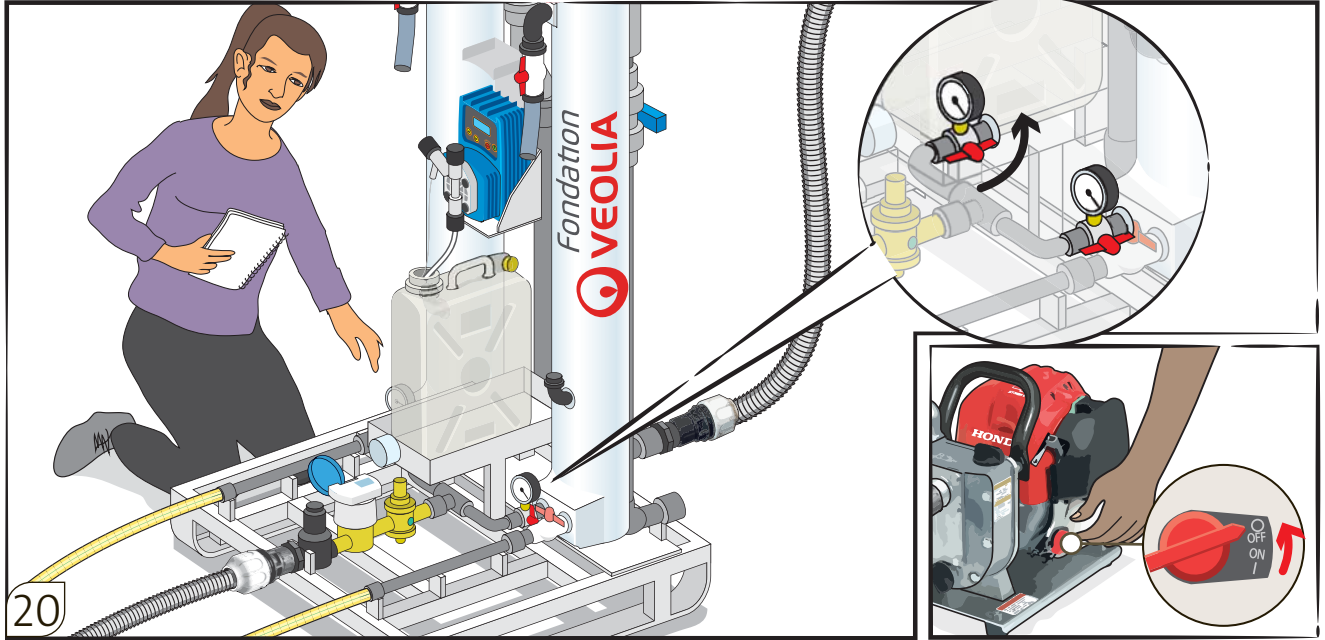
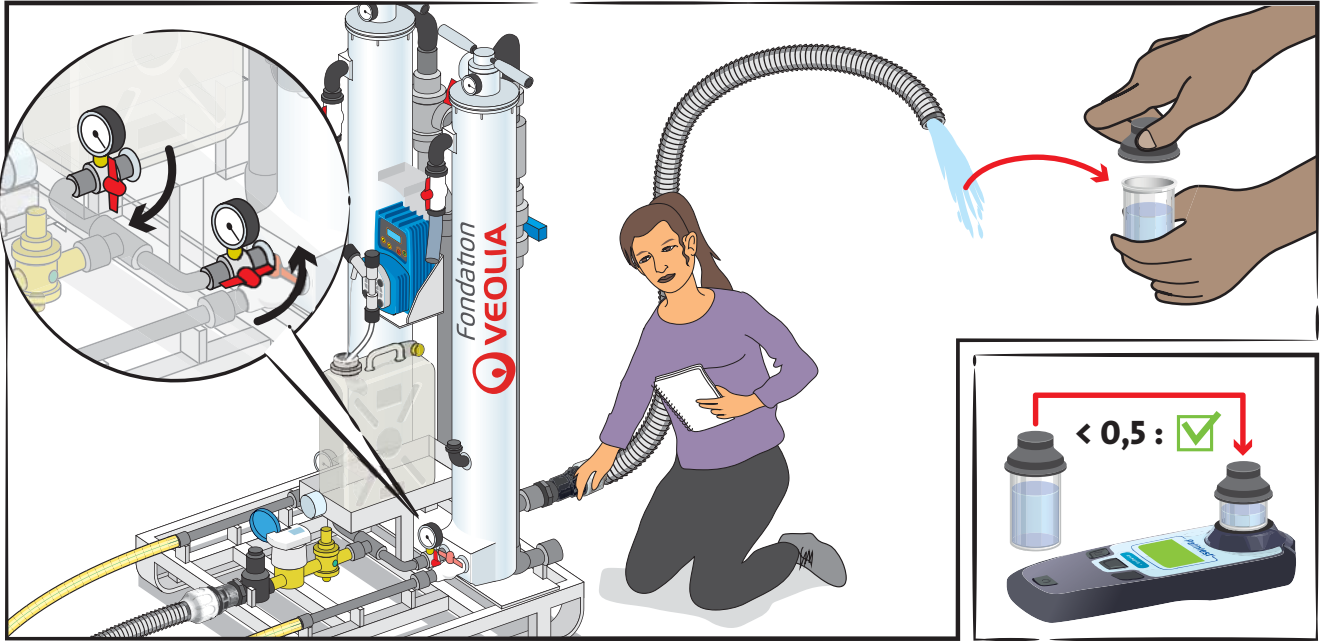
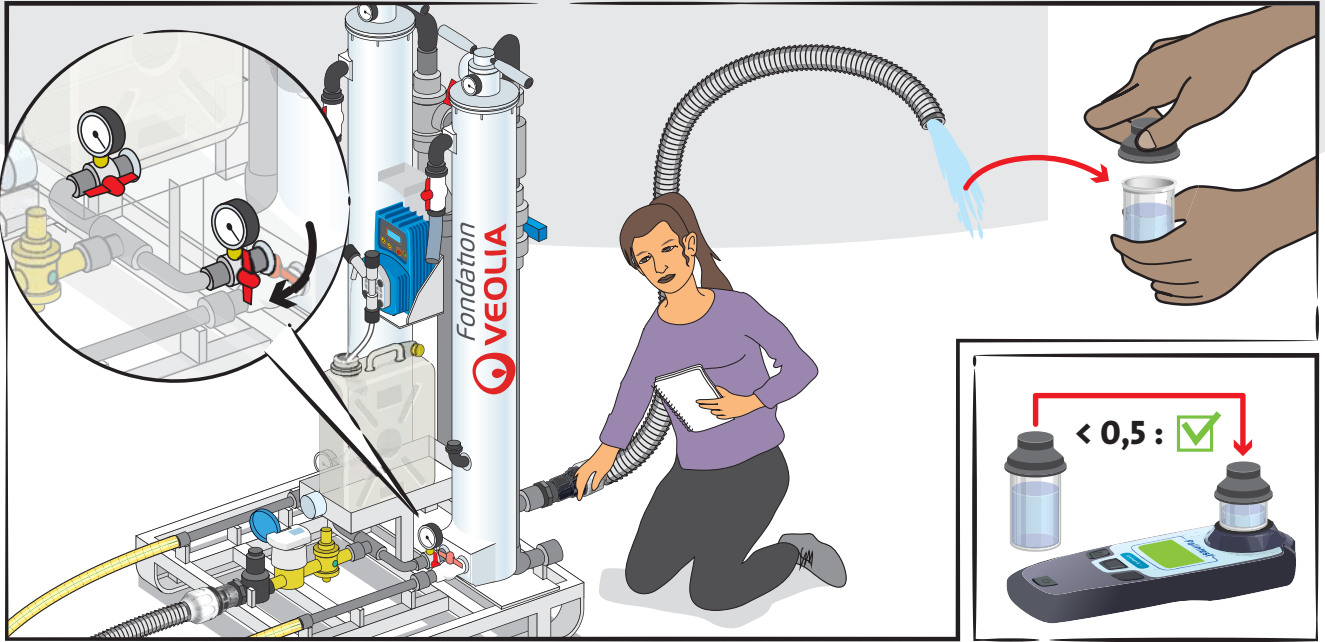

# 5 INSTALLATION DU FILTRE À CHARBON

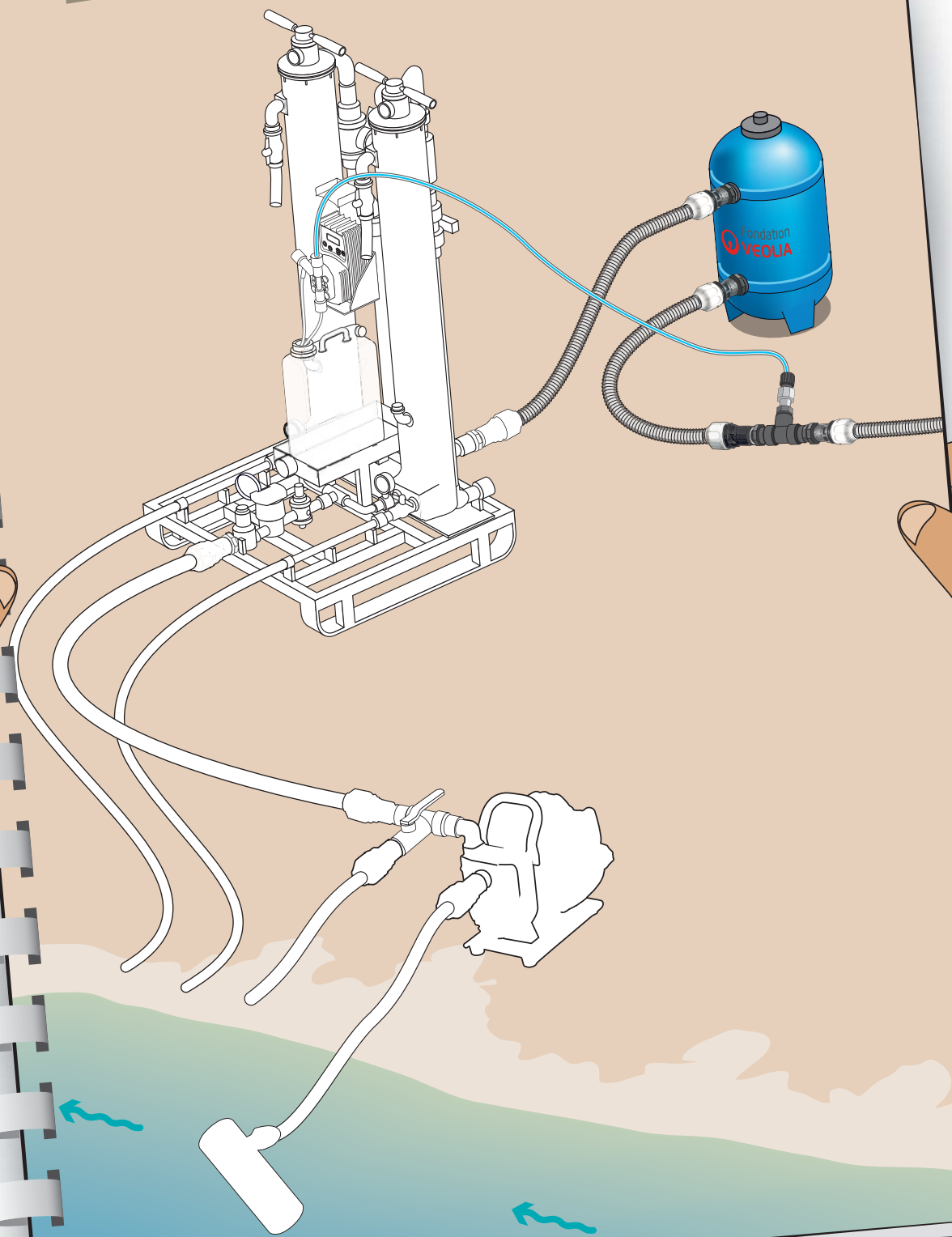

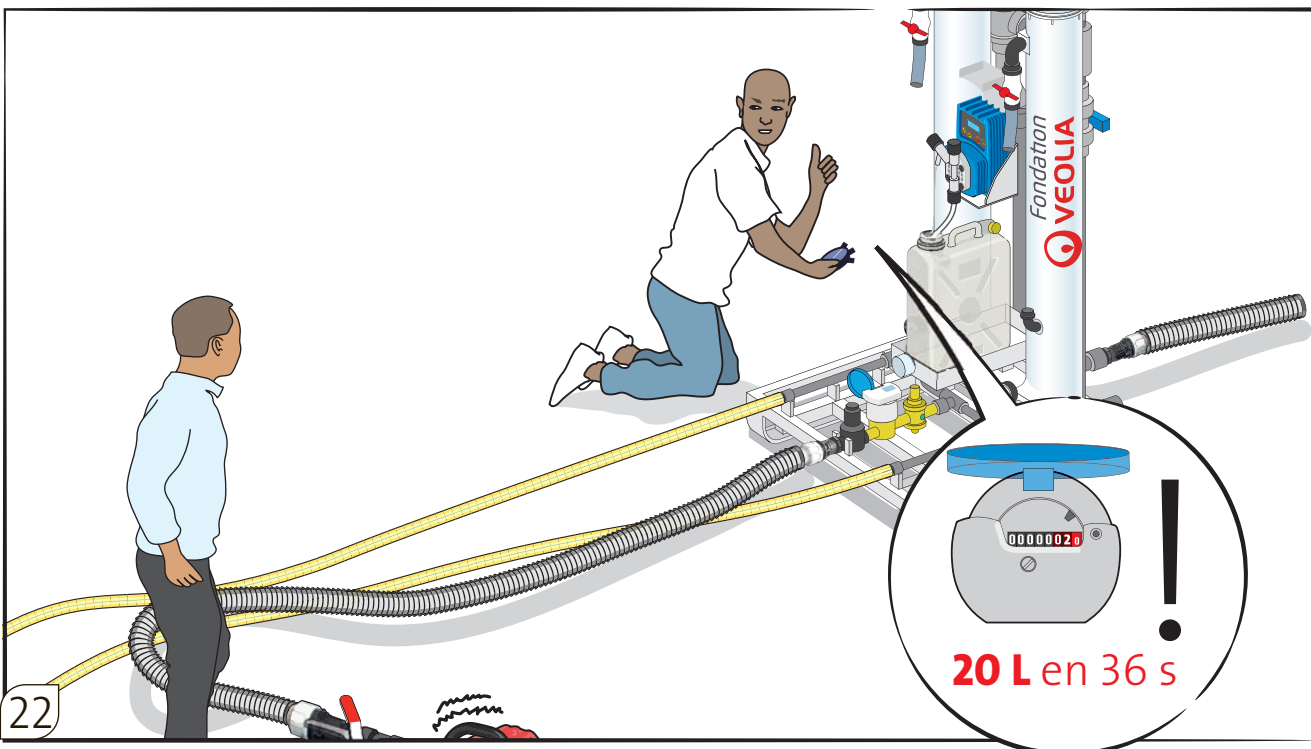
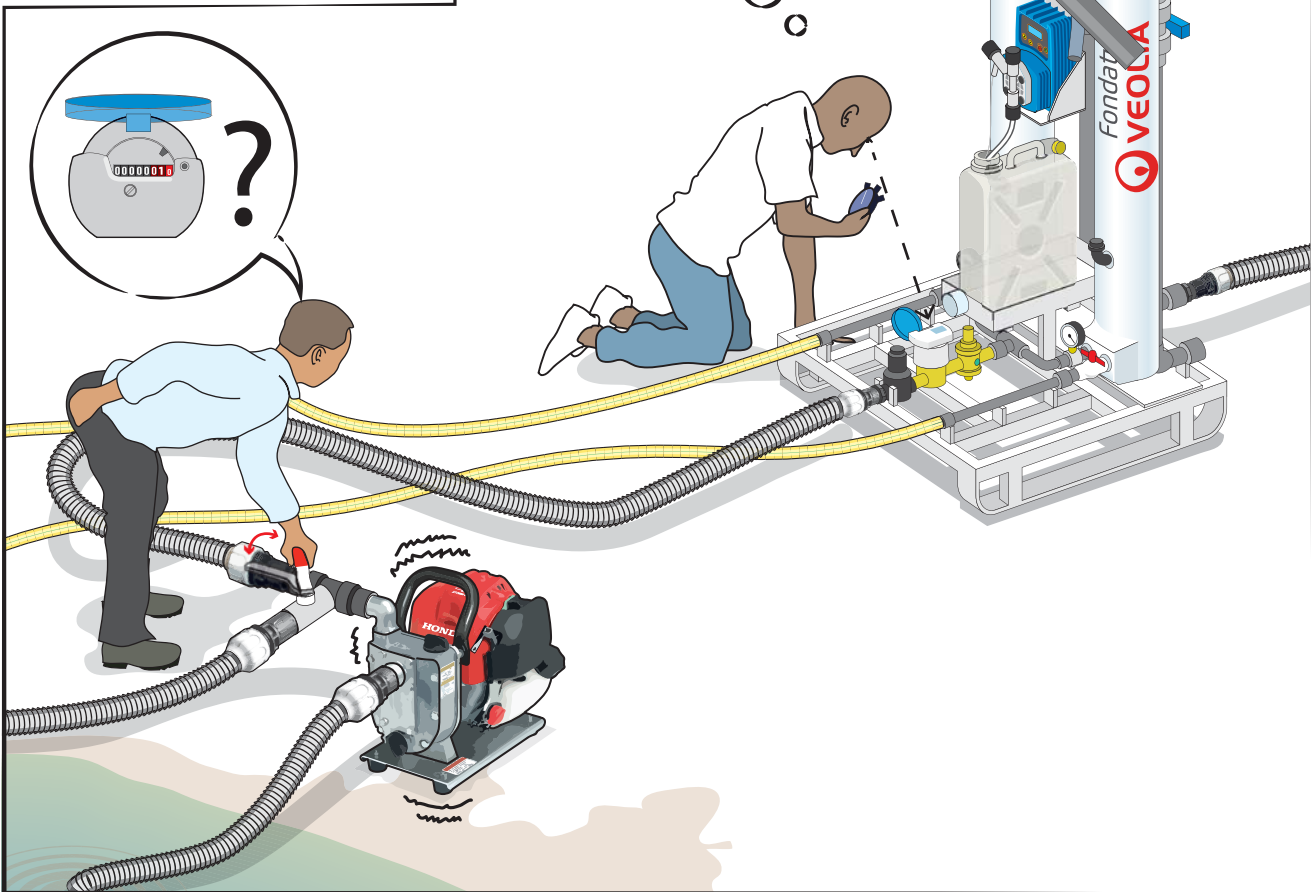
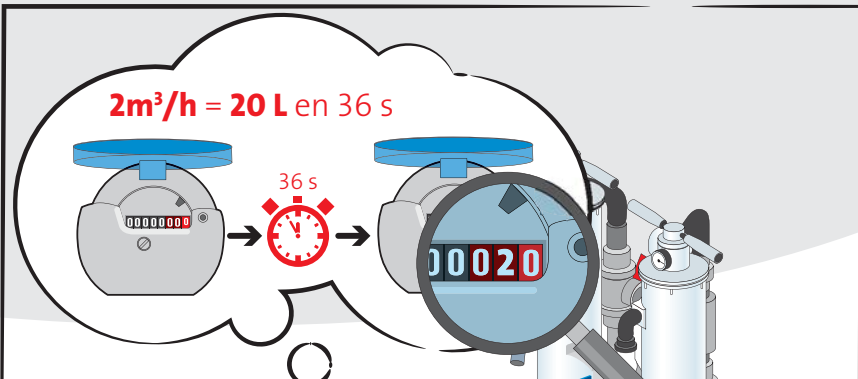
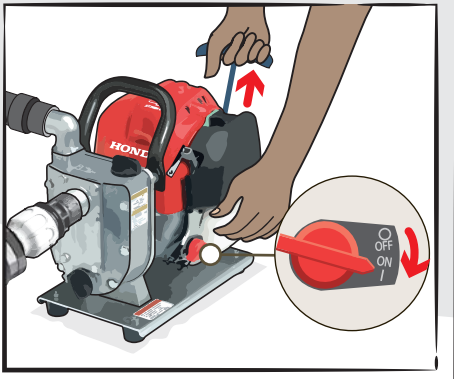

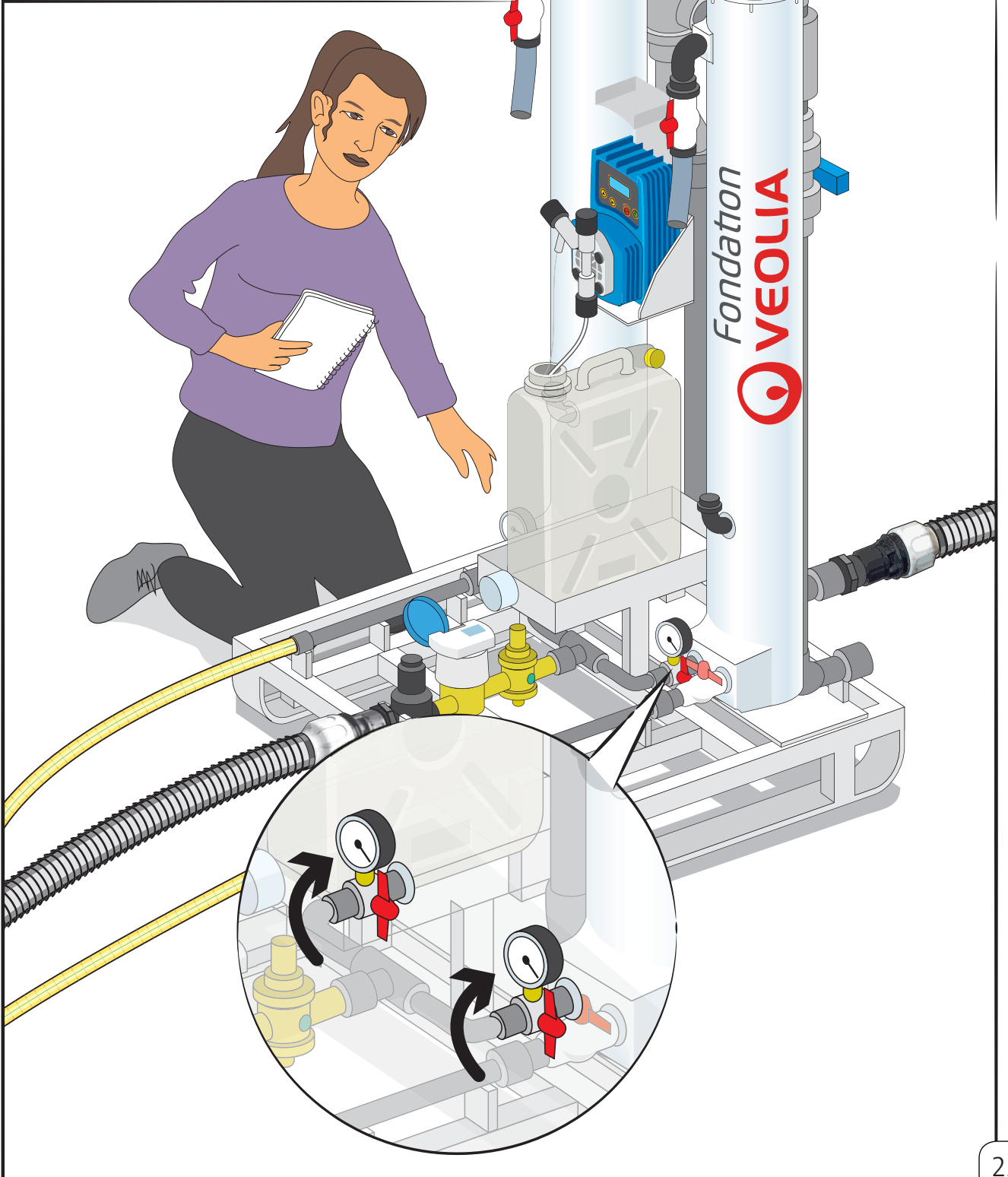
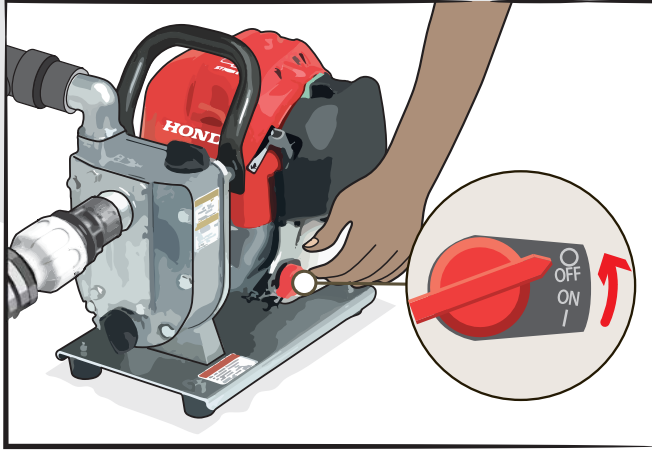

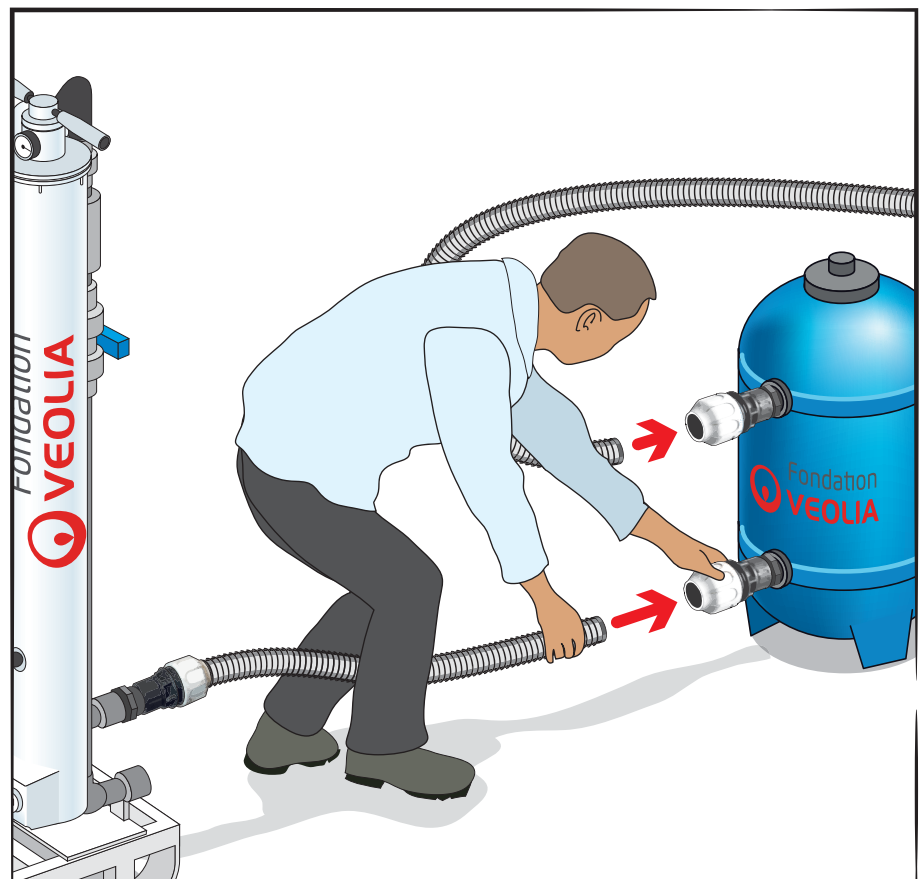
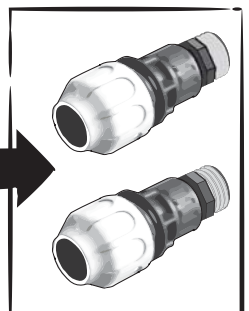
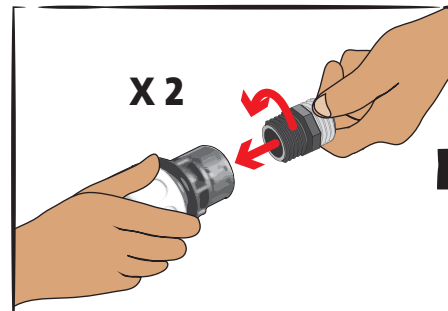
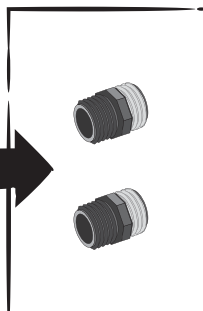
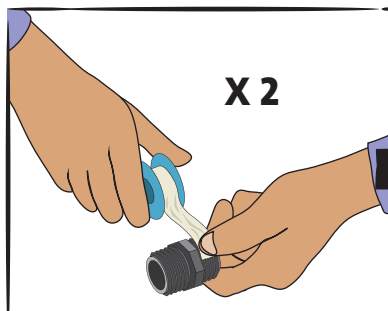
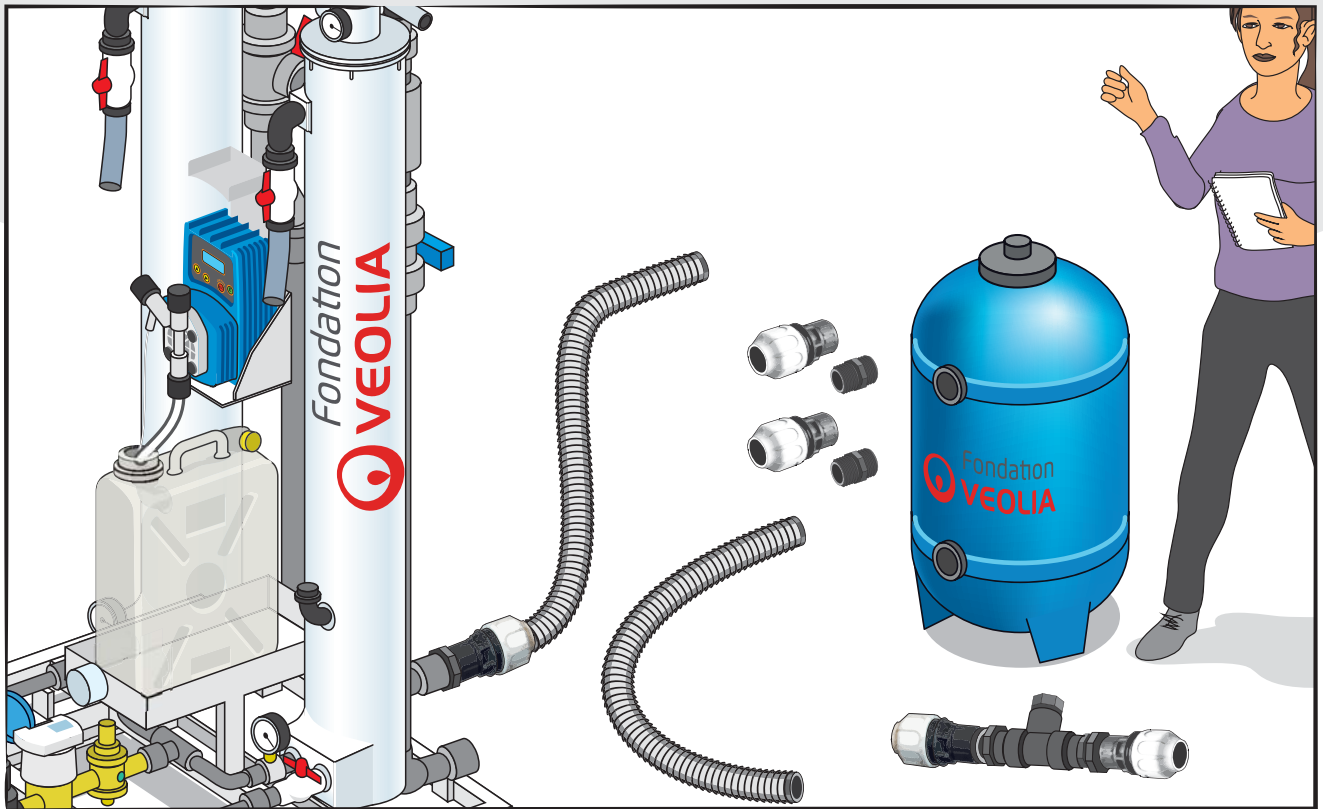



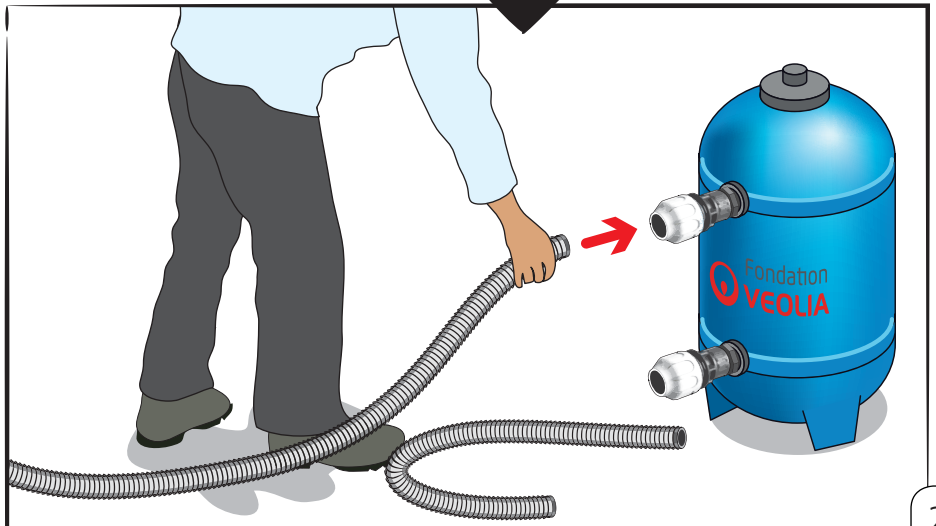
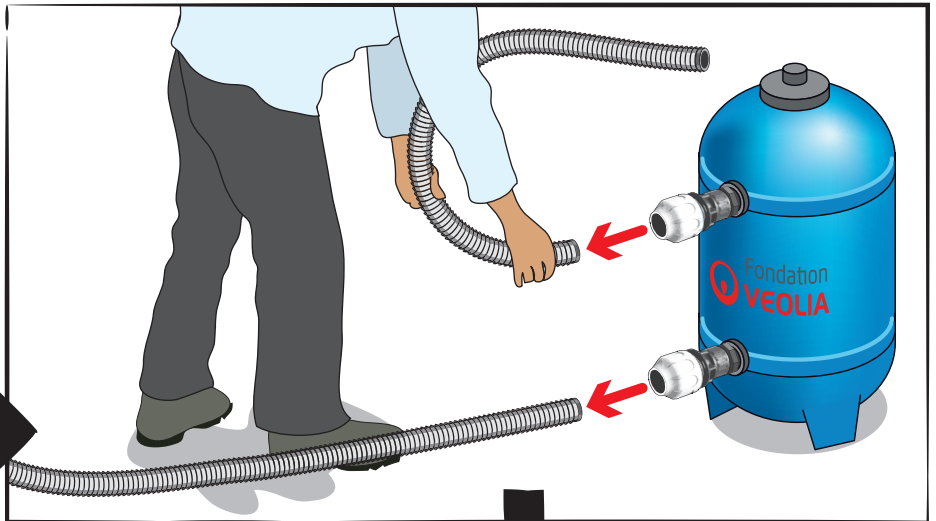
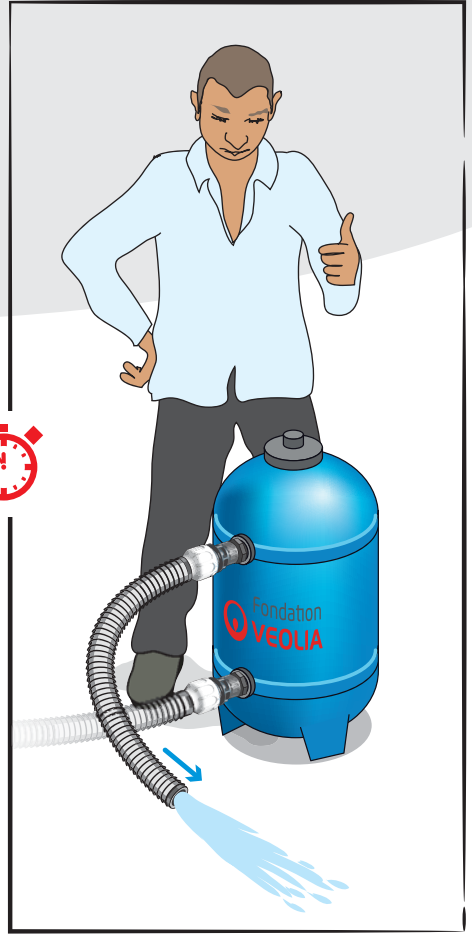
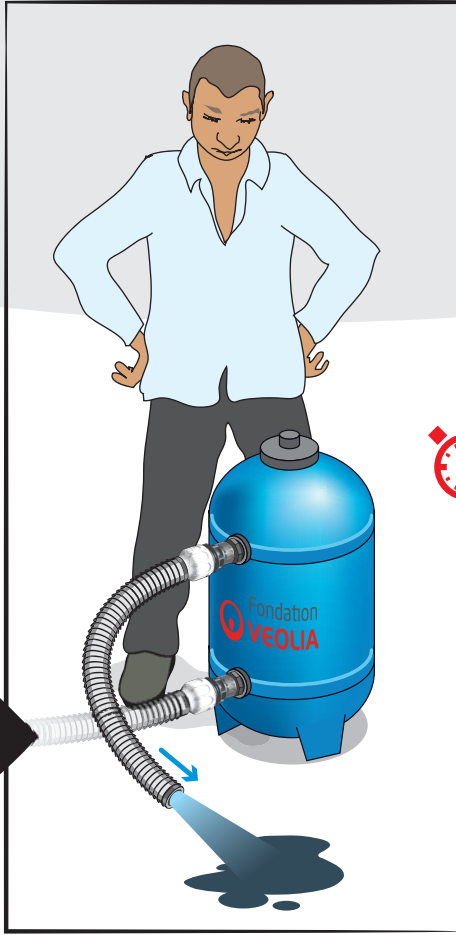
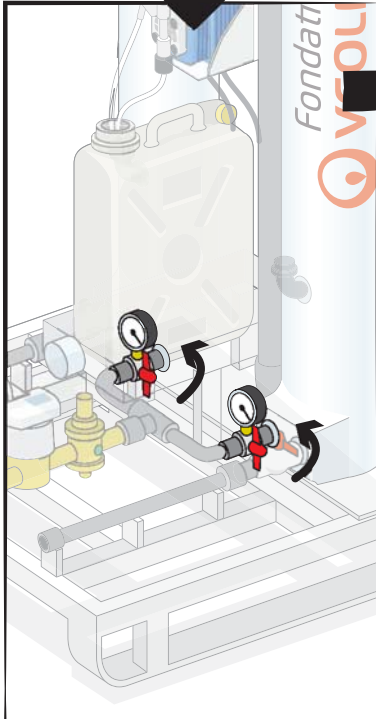
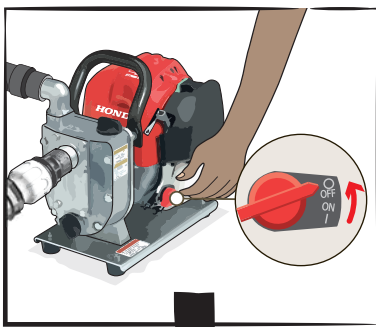
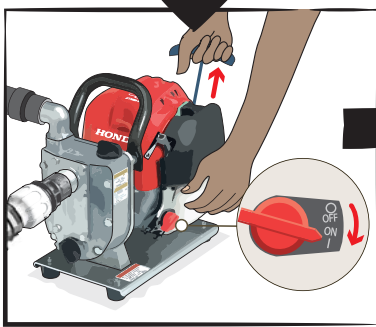
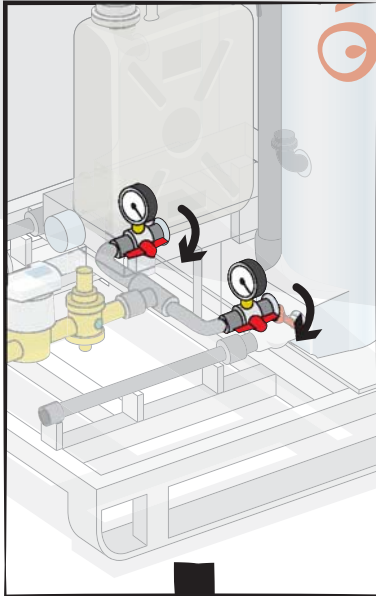

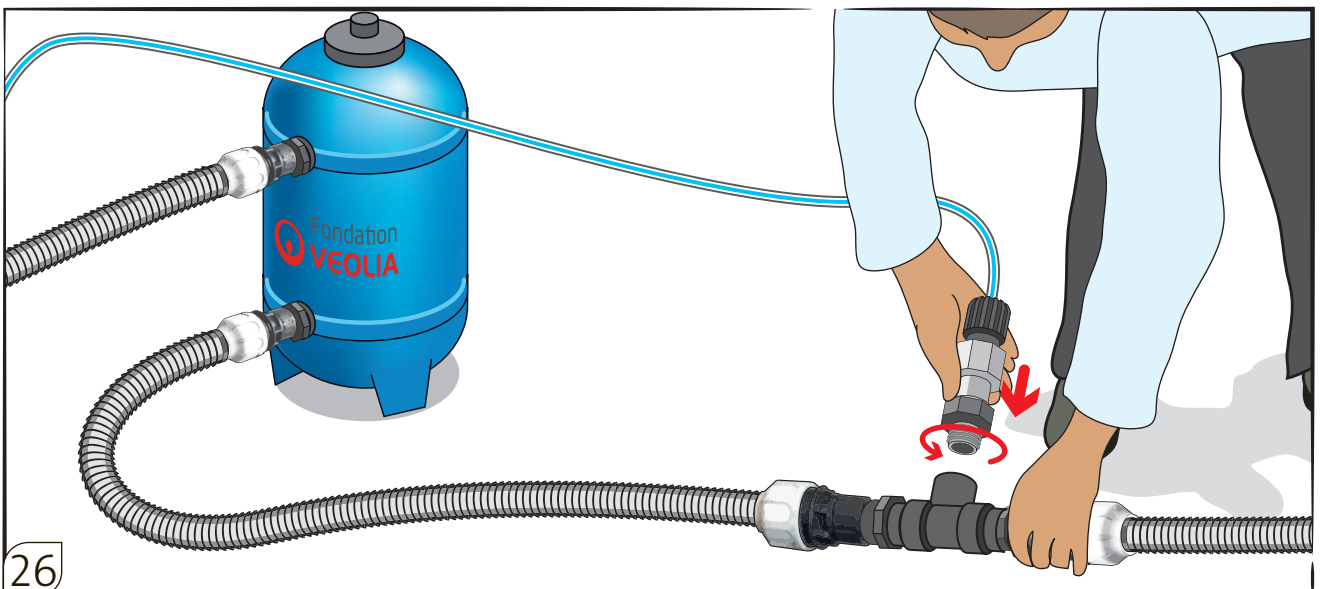
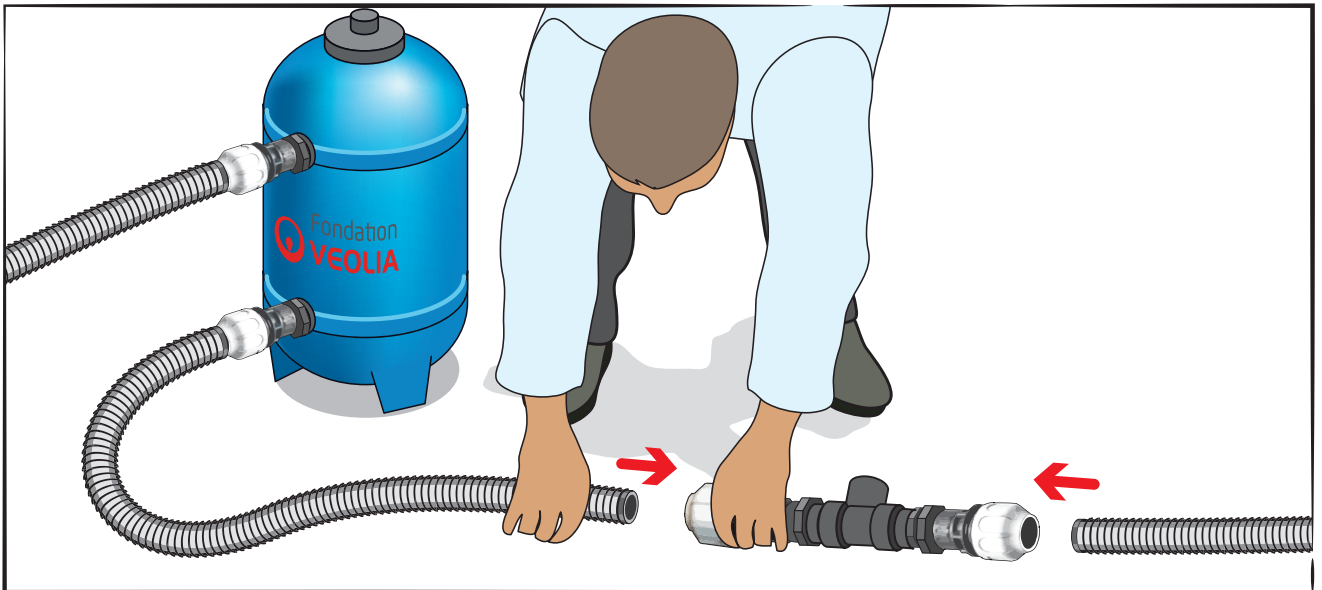
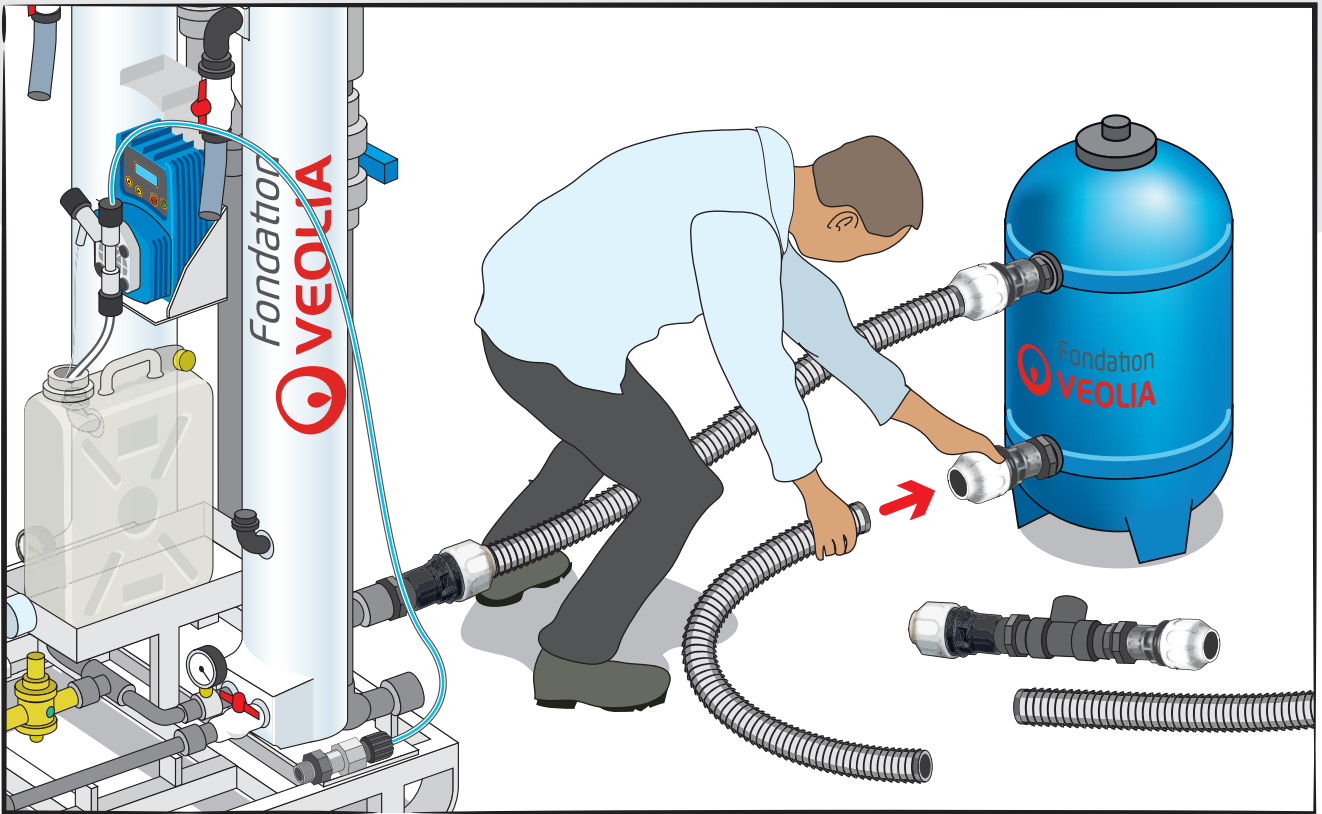

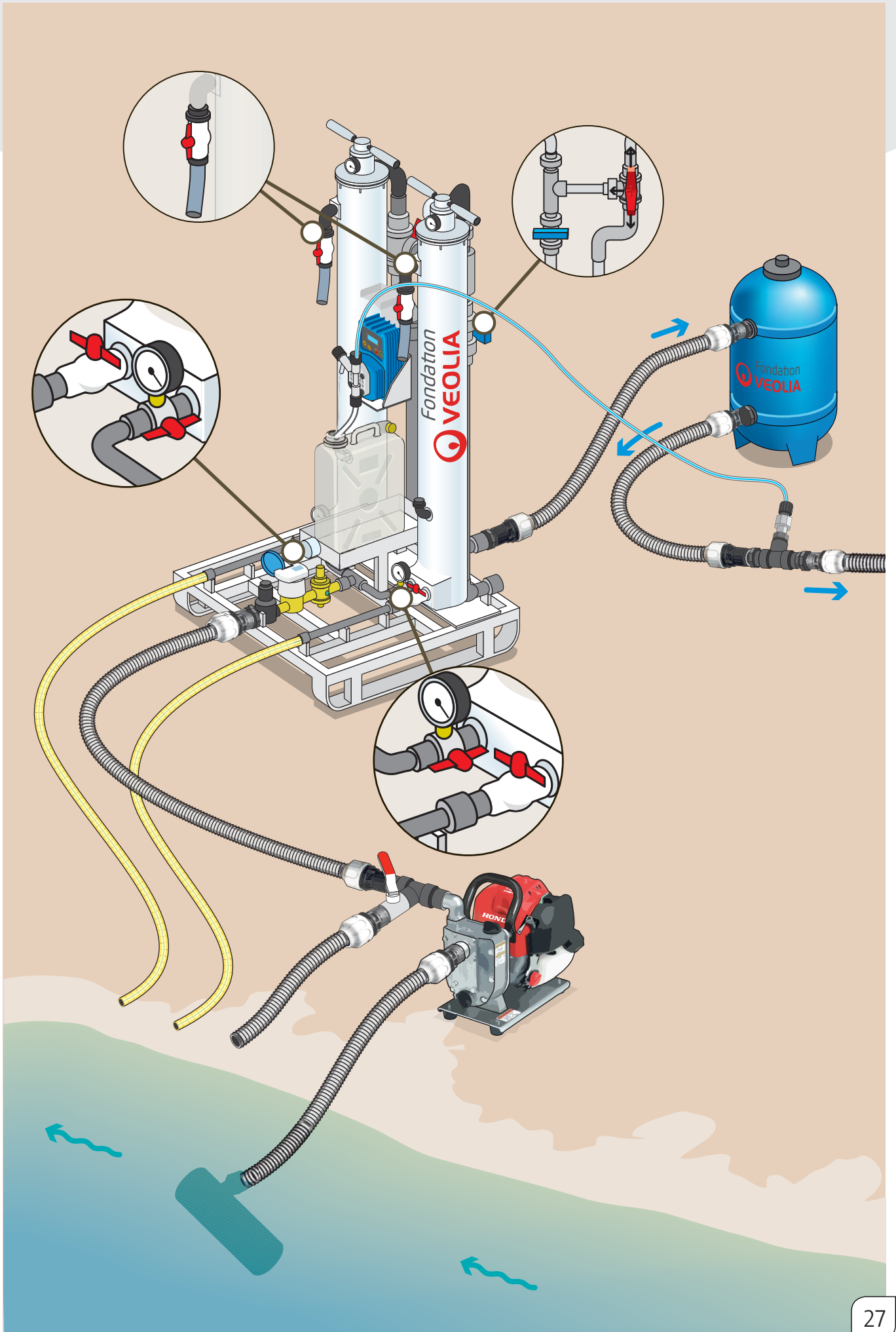

6 CHIMIE

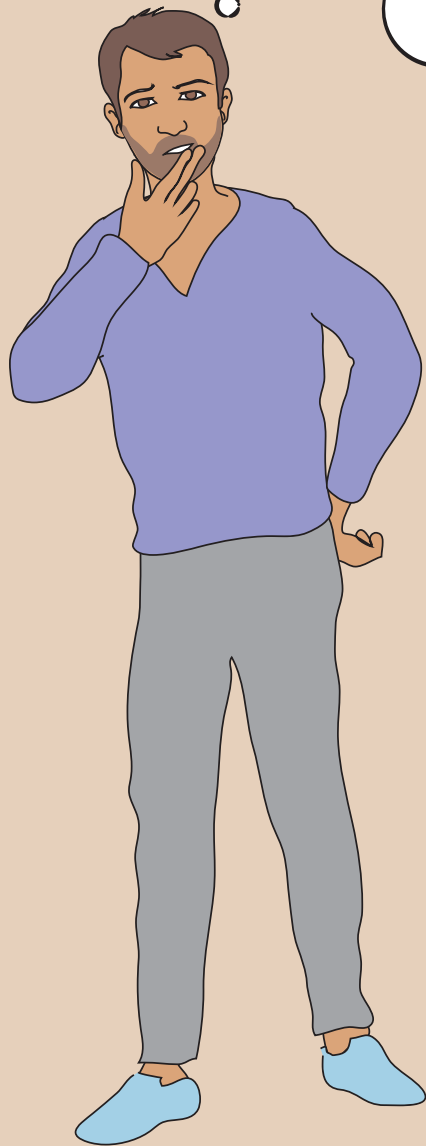
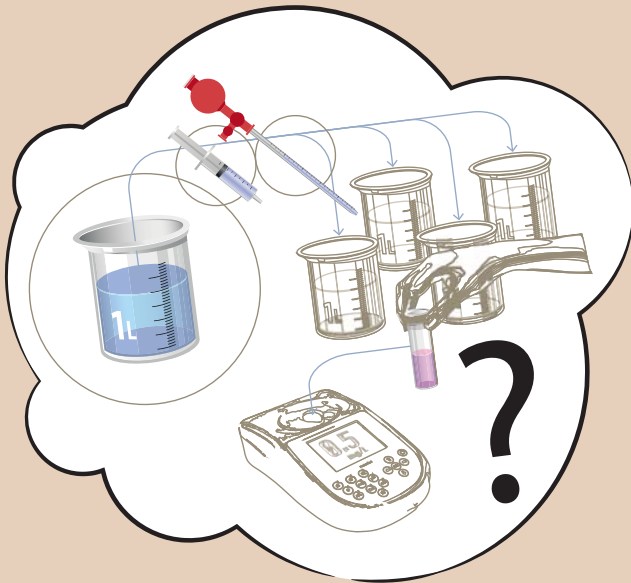

# INCIDENCE DU CHLORE SUR LA POTABILITÉ DE L'EAU

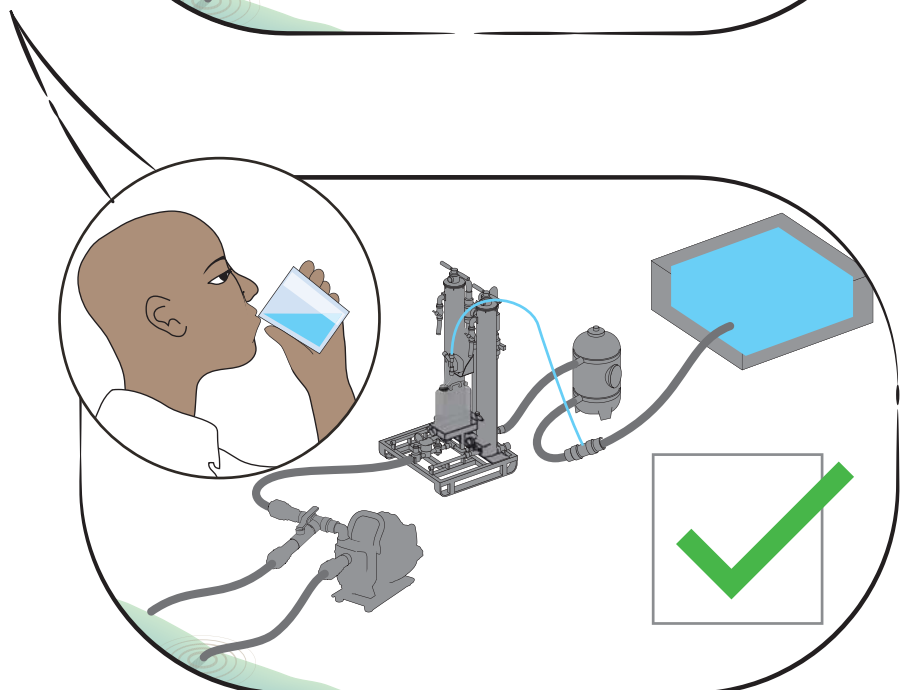
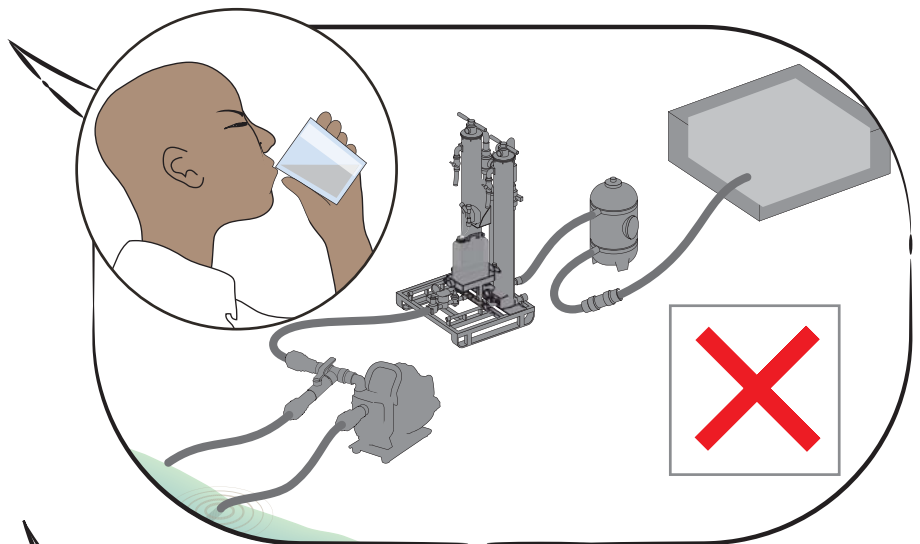
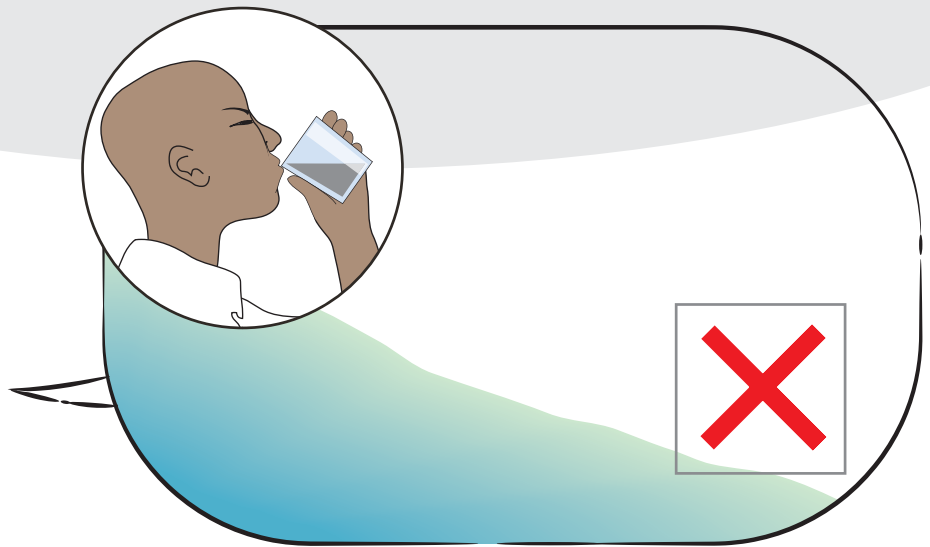
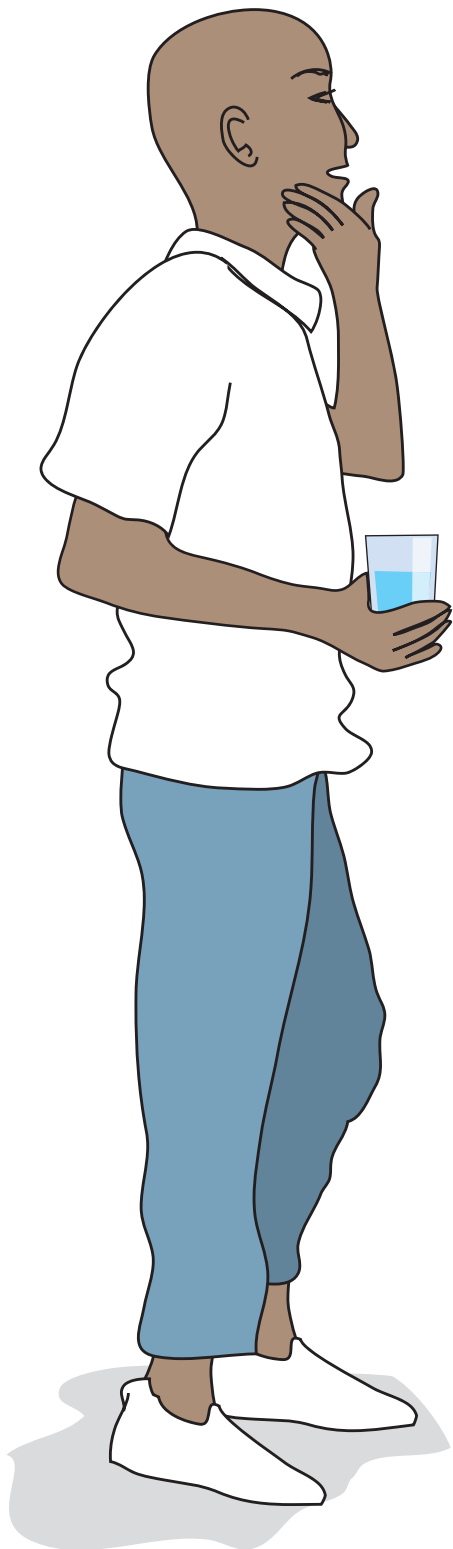

# SOLUTION MÈRE DE 10 L À 0,1 % (1 g/L)

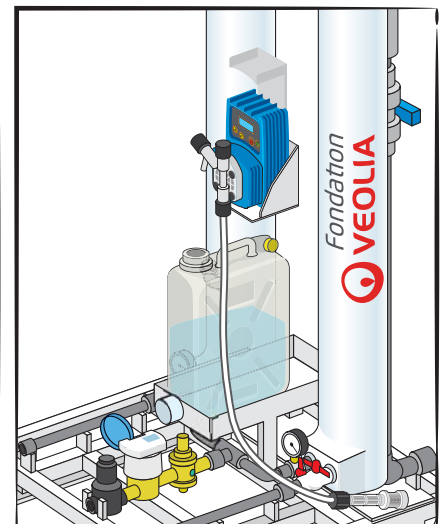
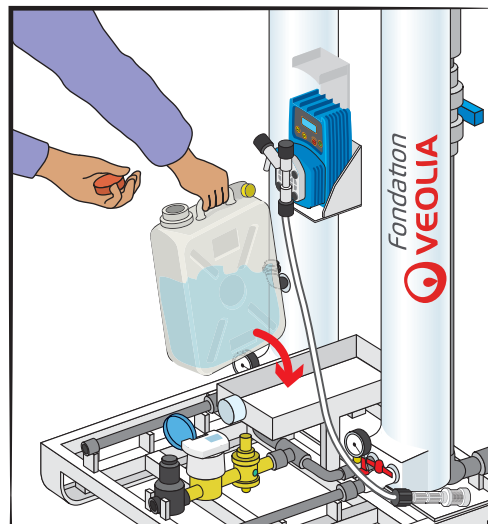
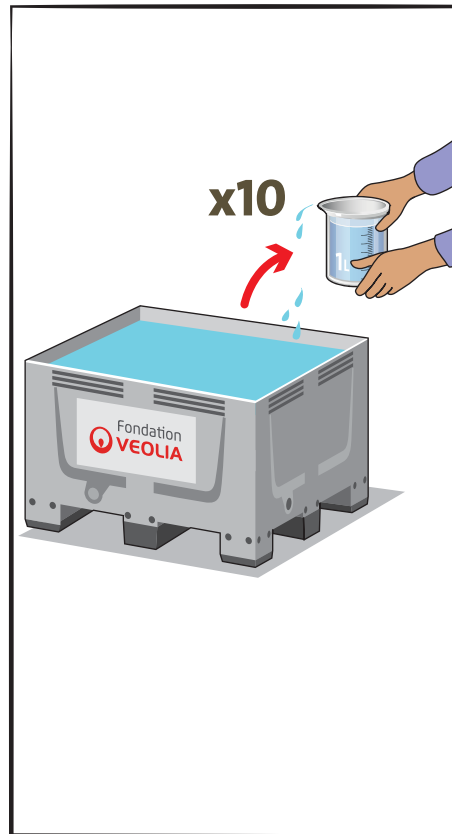
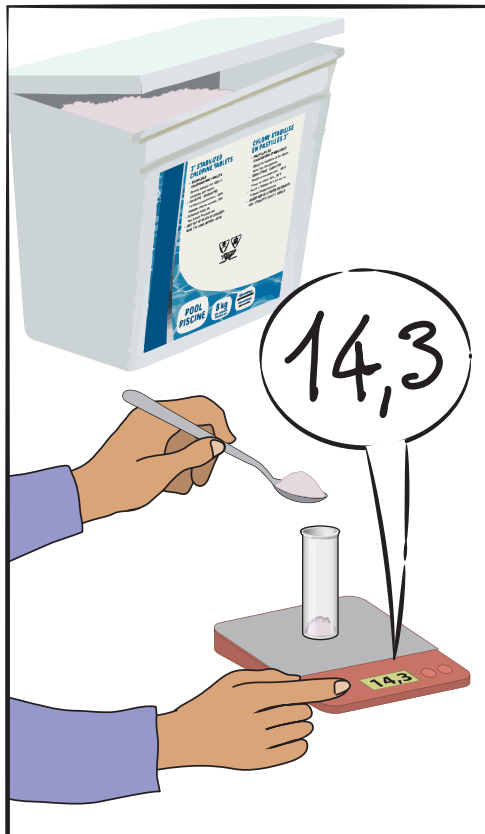
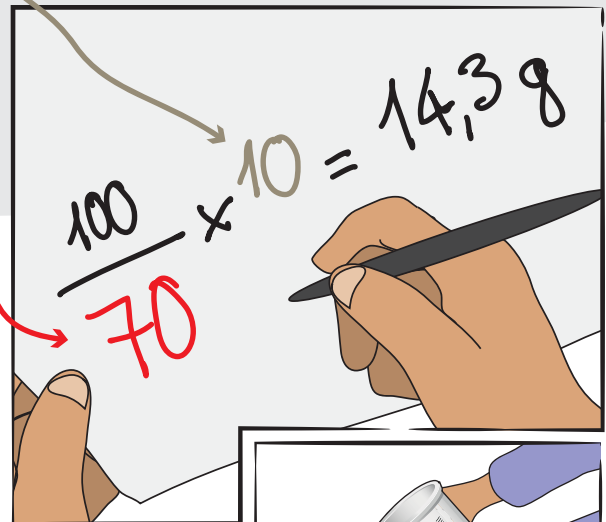

# LA POMPE DOSEUSE : Amorçage

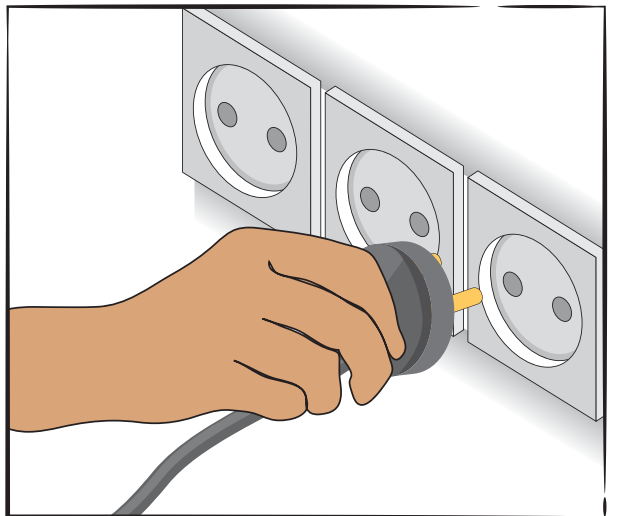
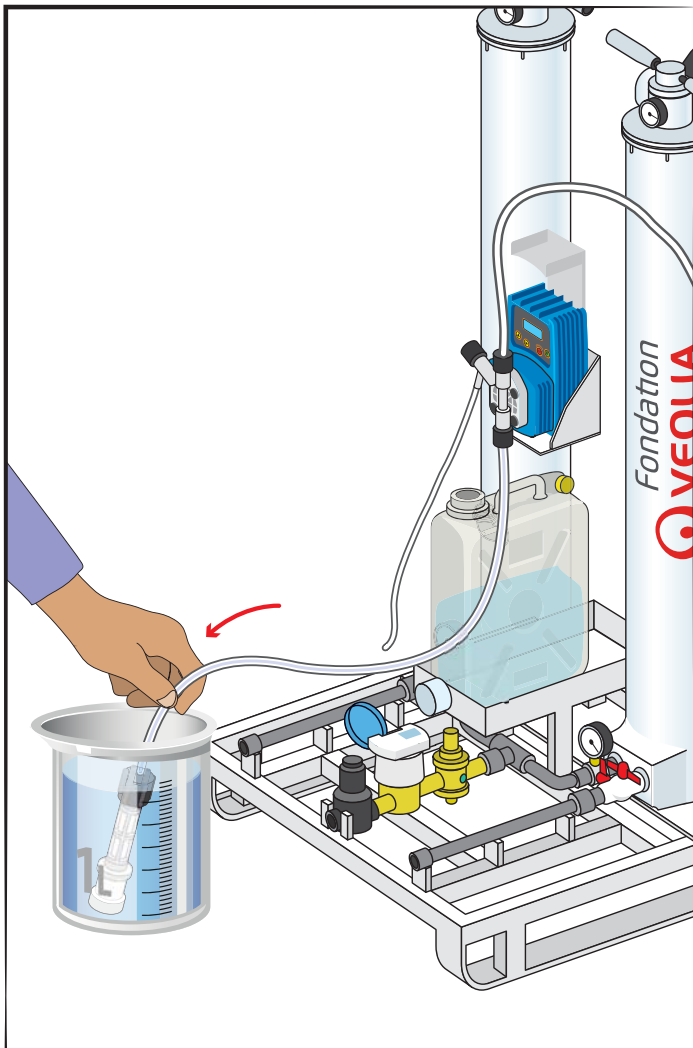
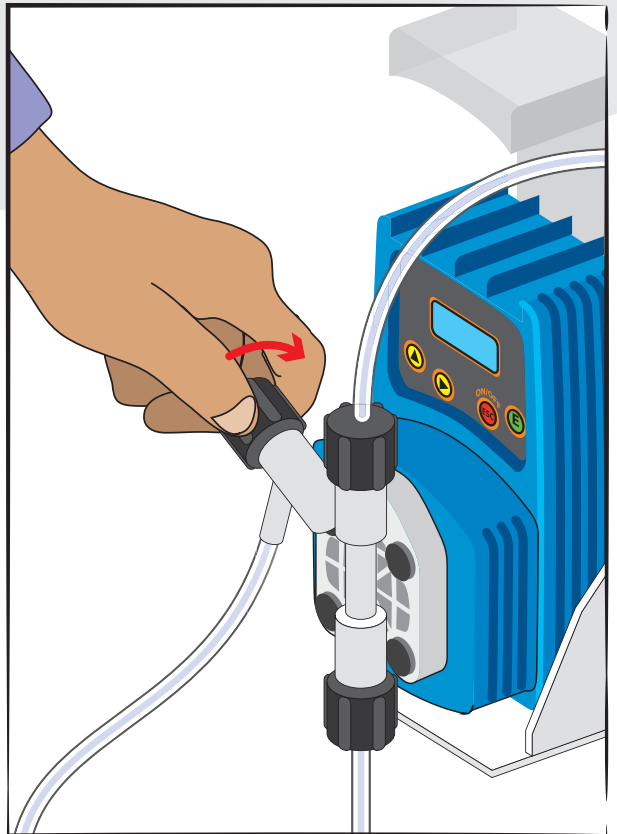
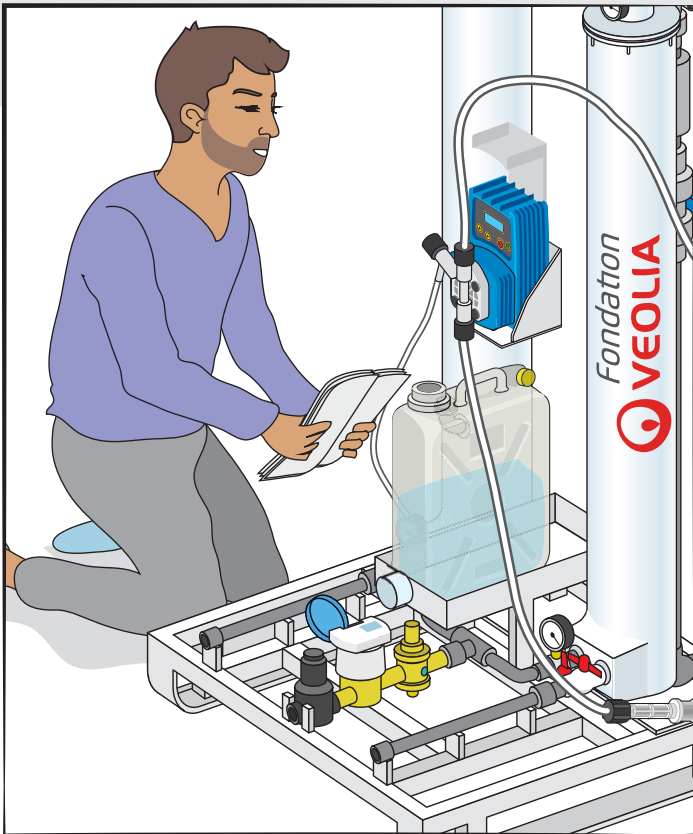

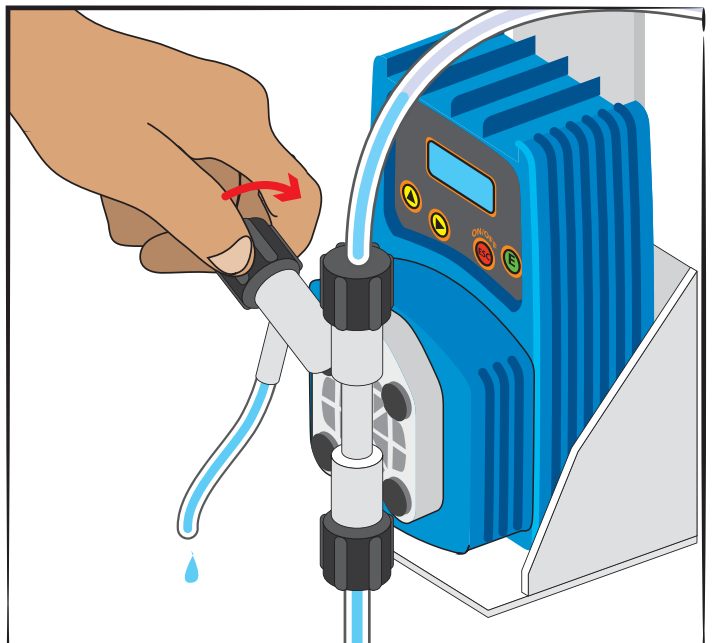
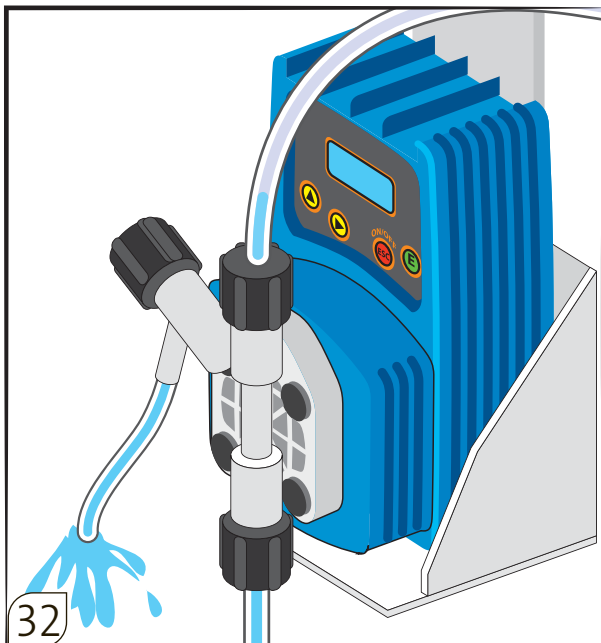
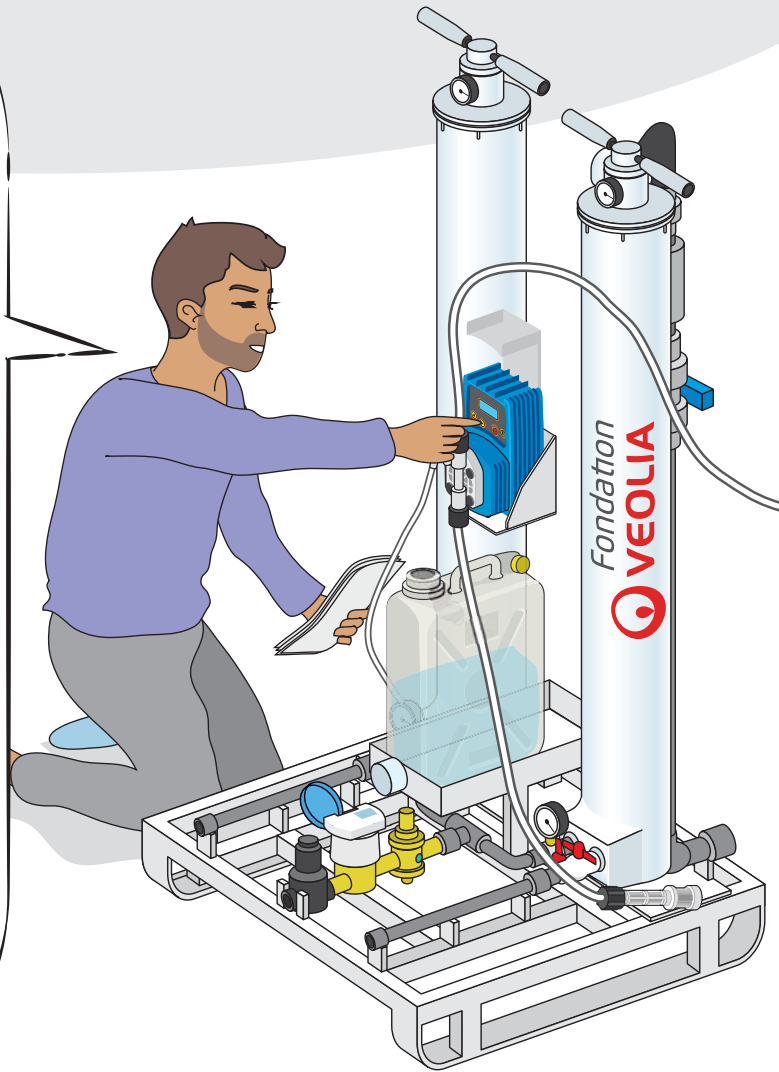
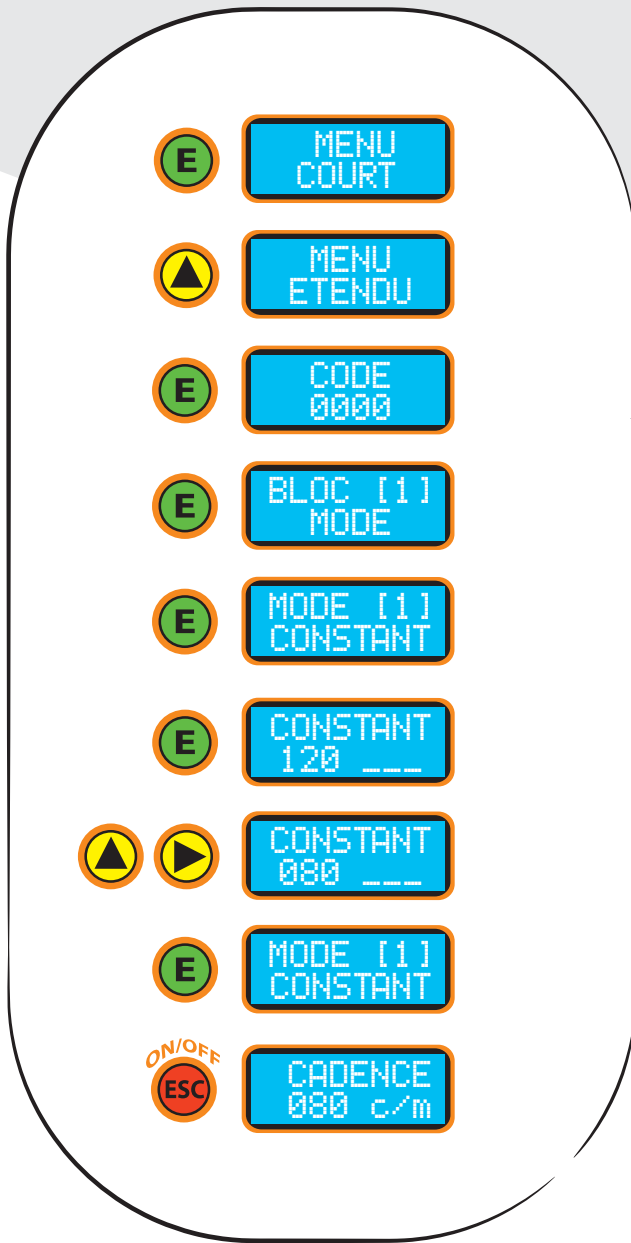



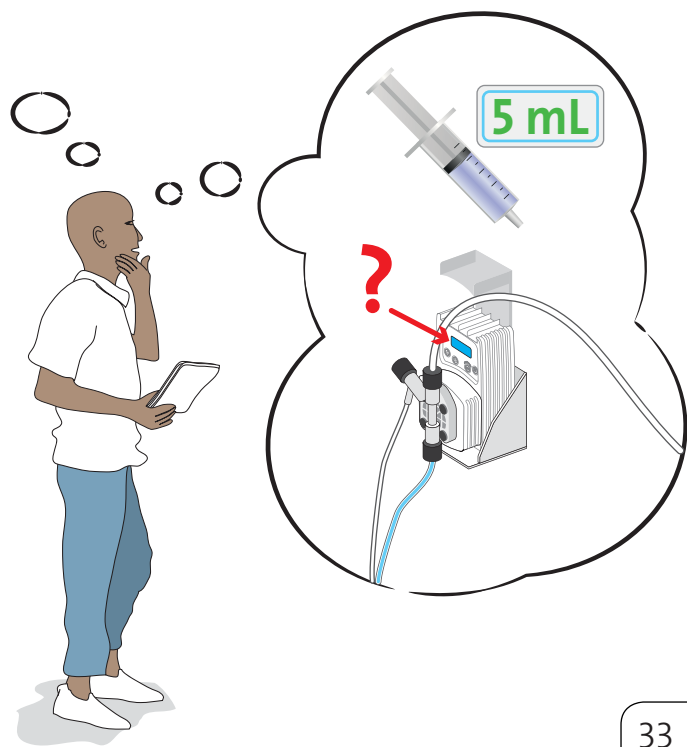
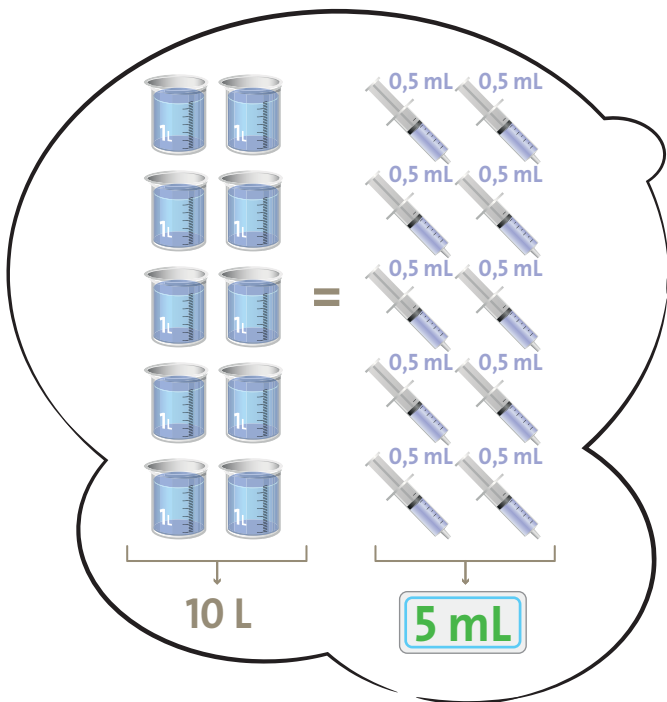
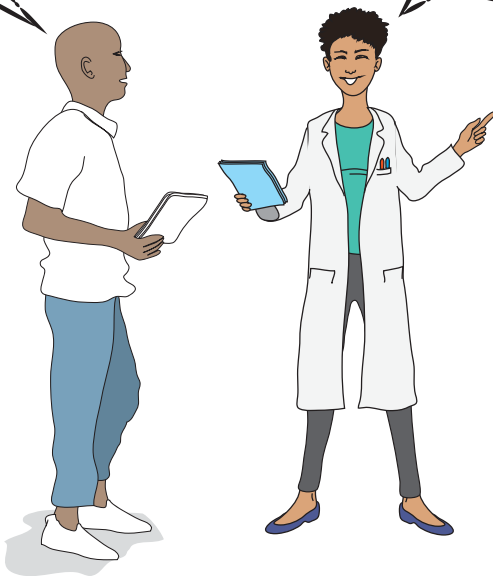
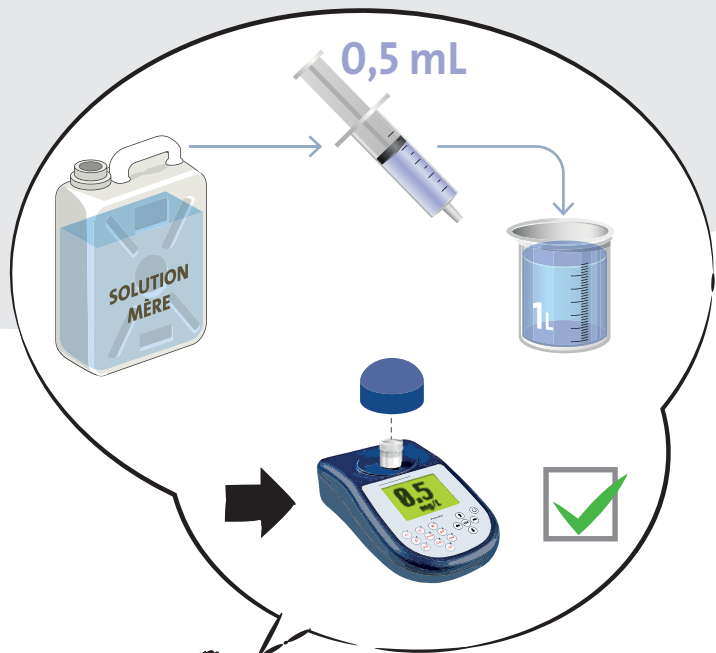
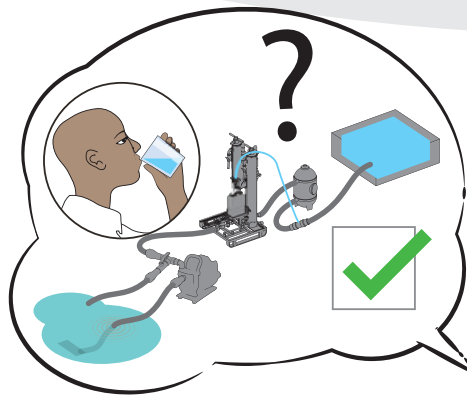

# LA POMPE DOSEUSE : Calcul du volume à injecter

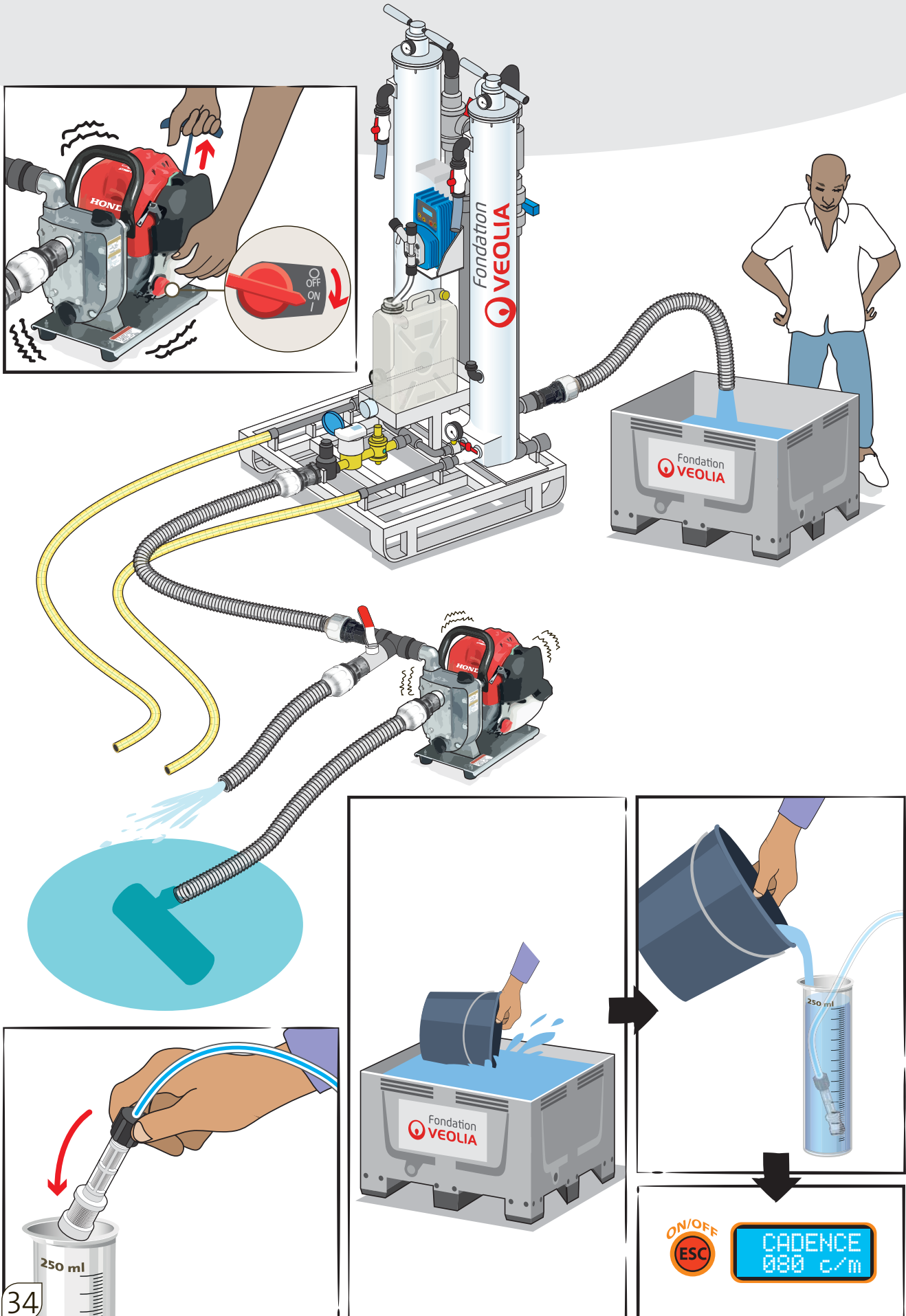

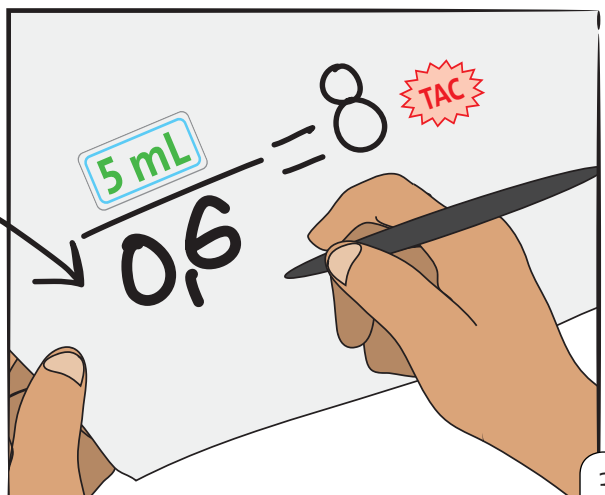
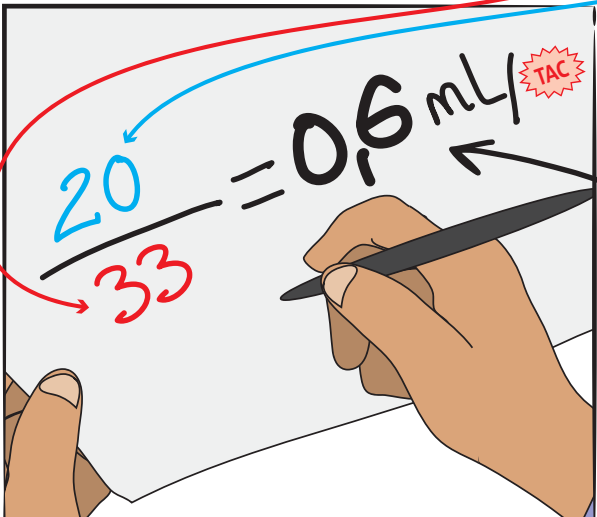
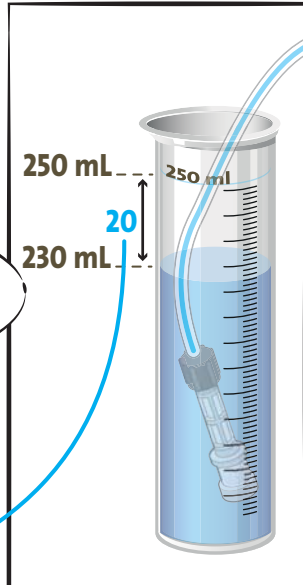
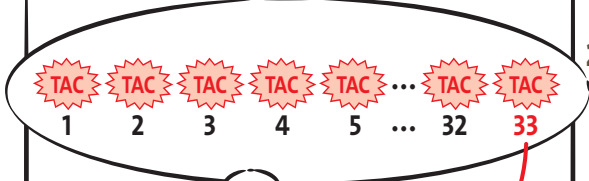
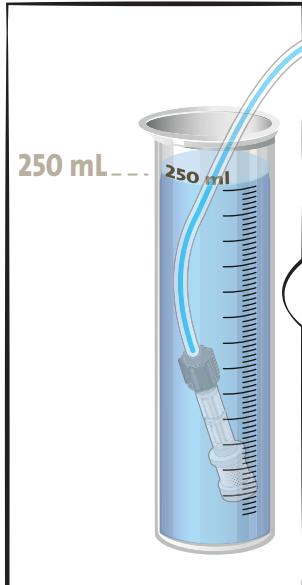
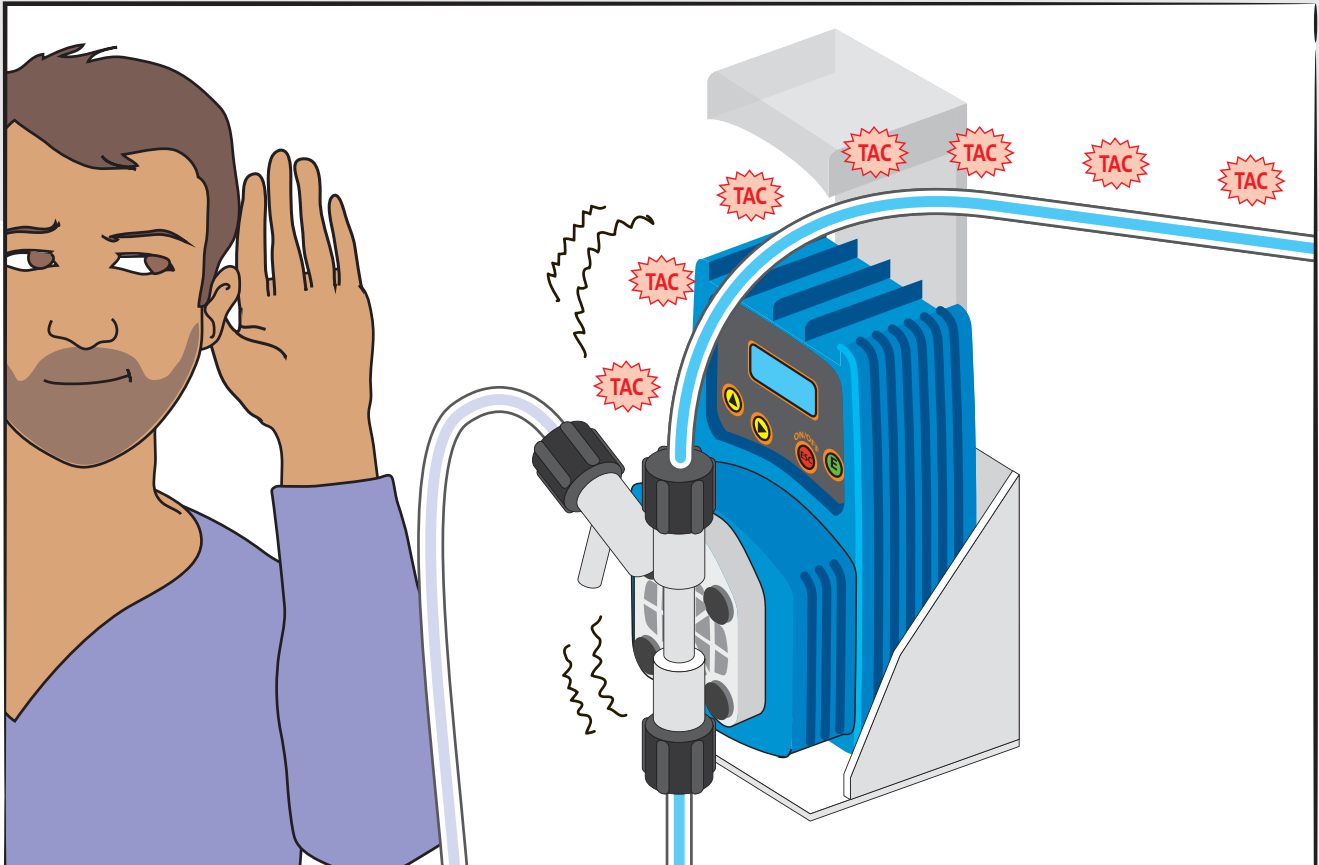

# LA POMPE DOSEUSE : Démarrage

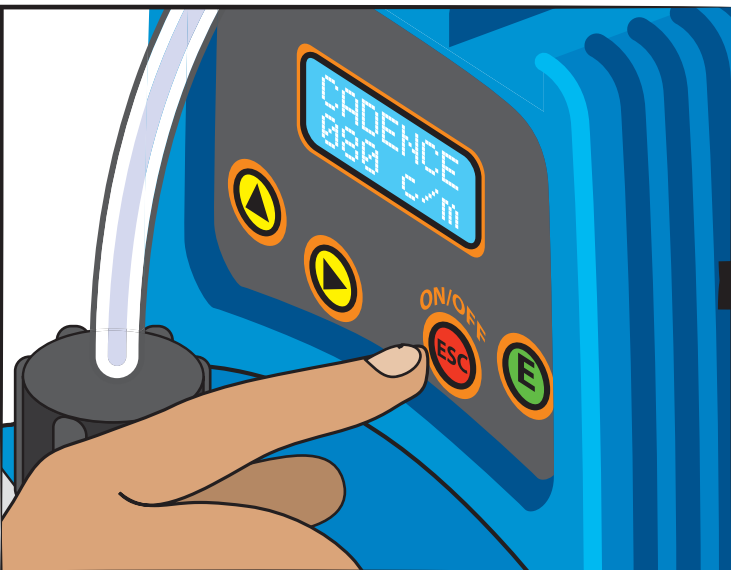
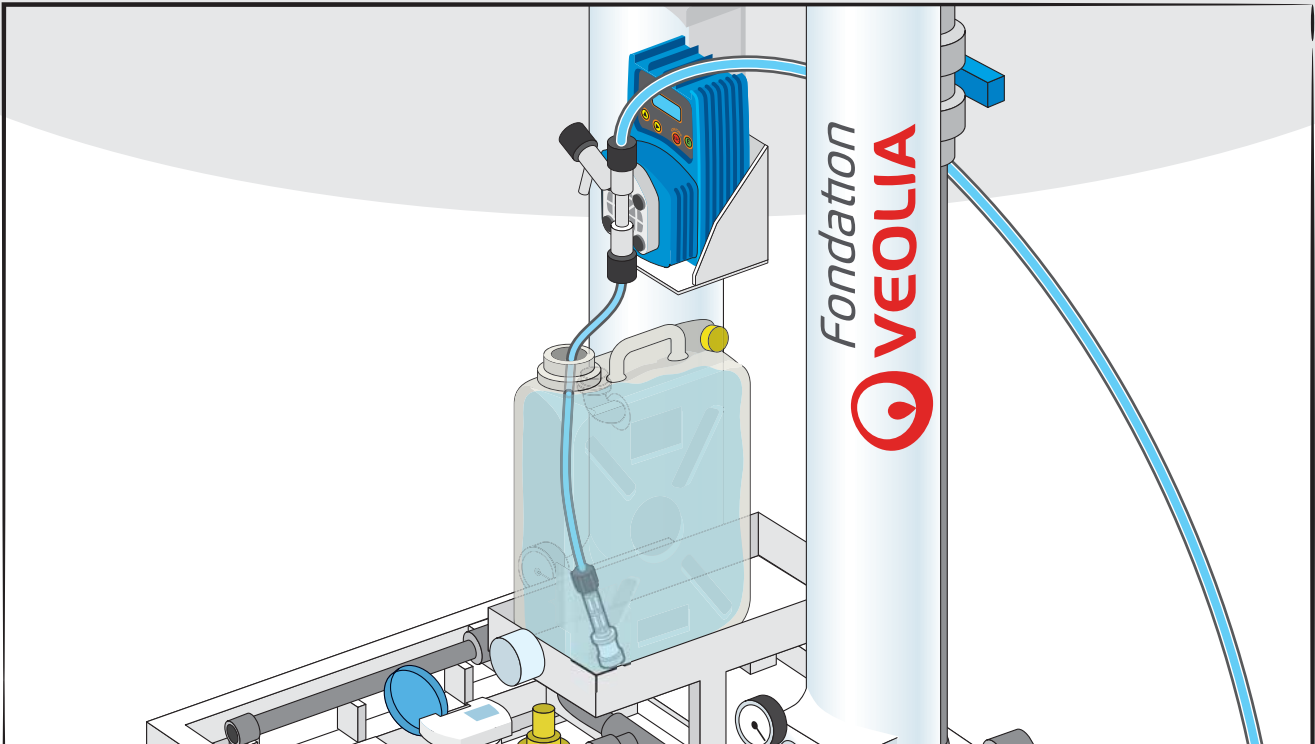

E	MENU COURT
▲	MENU ETENDU
E	CODE 0000
E	BLOC [1] MODE
E	MODE [1] CONSTANT

▲	MODE [3] MULTIPLI	
E	MULTIPLI _ .00	
▲	▶	MULTIPLI _ 8.00
E	MULTIPLI _ 8. _ 0	

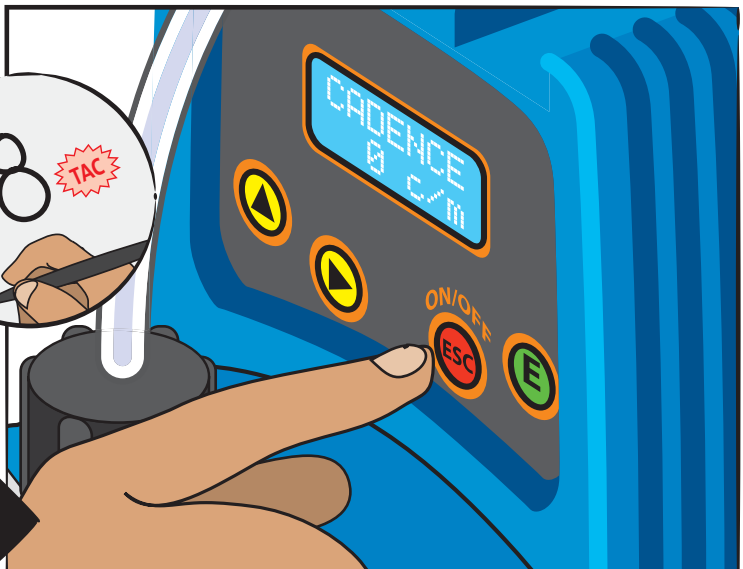

# 7 PRODUCTION

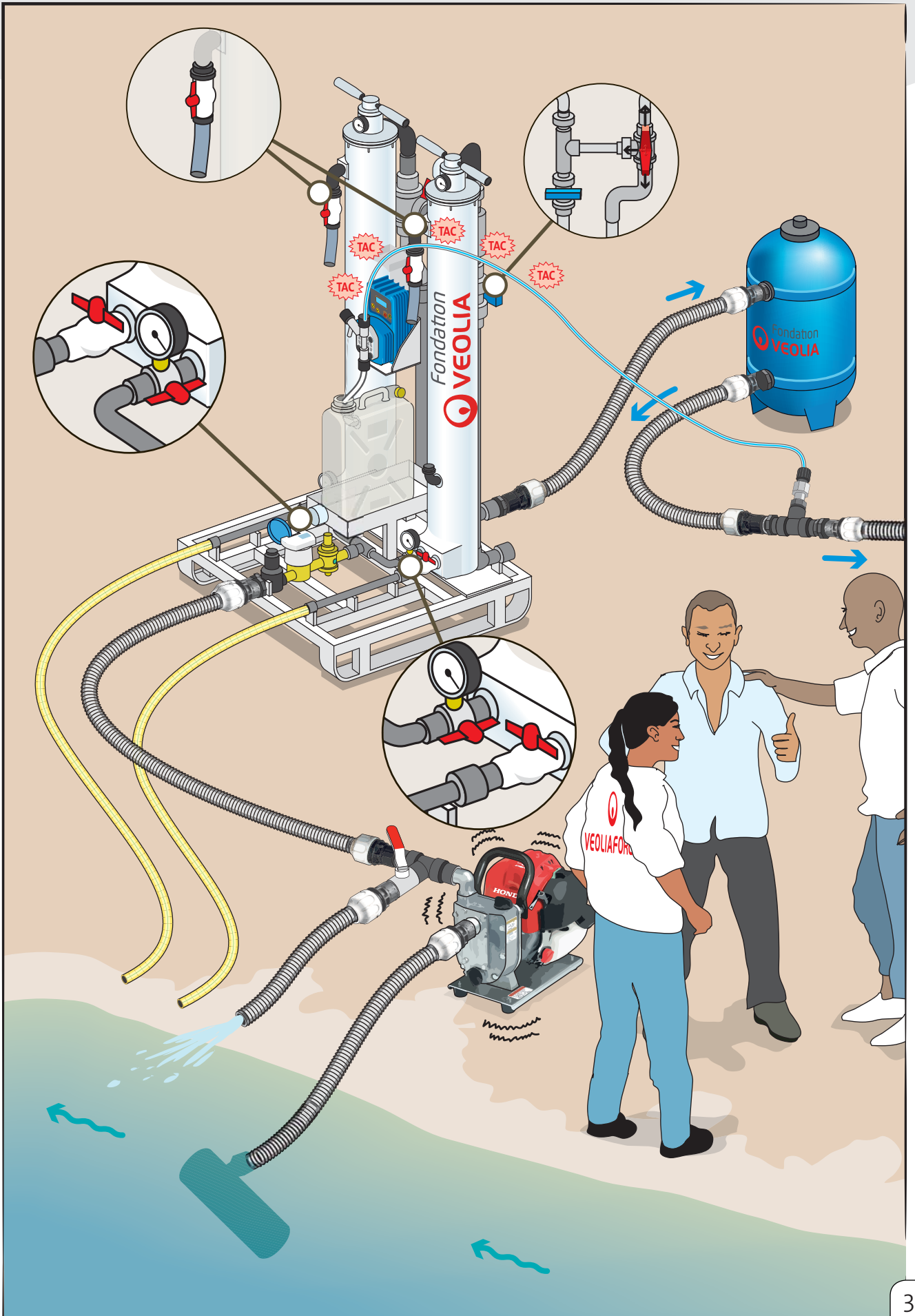

# 8 EXPLOITATION

